

PASSPORT IS®

2"sq x 12ga UPRIGHTS & DIAGONAL BRACES | 2.75"sq PALES | 2" x 4" x 11ga BOTTOM RAIL (notched & plated for v-track wheels)

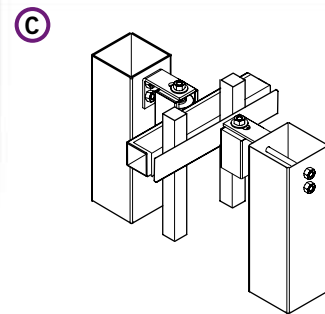
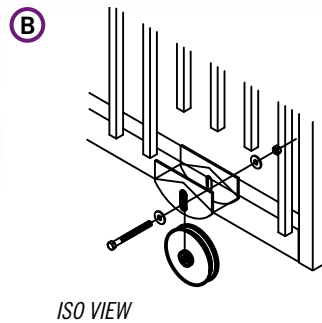
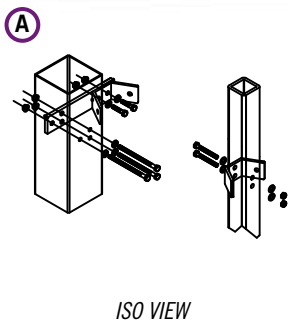
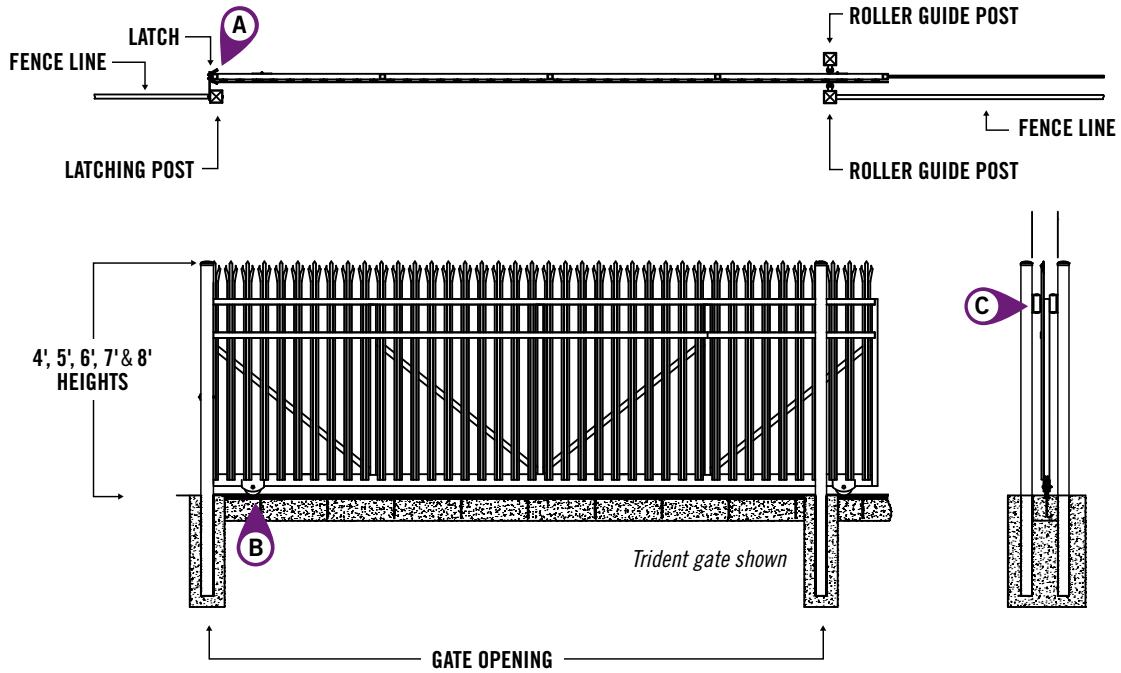

ROLL GATE SAFETY WARNING

PassPort Roll Gates are supplied with 2" mesh safety screening in sufficient quantities to cover the entire gate and an equal portion of fence parallel to the gate in the open position up to a height of over 6 feet from ground elevation. ***This screening must be included when the PassPort Gate is installed at the jobsite. Additionally, all of the safety requirements of ASTM F2200 must be met during installation. Failure to incorporate the safety mesh or follow ASTM F2200 safety requirements during gate assembly and installation will cause rejection of the entire gate system any time an attempt is made to attach the gate to an automatic gate operator. Ameristar assumes no responsibility for gate installations that fail to utilize the materials provided or meet the applicable safety standards.***

Refer to construction specification & tables within this section for more details.

Effective: 08/14/18

PASSPORT IS® | 2-RAIL ROLL GATES

POSTS & HARDWARE SOLD SEPARATELY | OPENINGS OVER 30' HAVE A 2-PIECE FRAME

OPENING	LENGTH	ITEM NUMBER	WEIGHT	PALE QTY
6' HEIGHT	4' - 6'	3☒Ⓞ207006R*	280 lbs	16
	6' - 8'	3☒Ⓞ207008R*	328 lbs	20
	8' - 10'	3☒Ⓞ207010R*	377 lbs	24
	10' - 12'	3☒Ⓞ207012R*	427 lbs	28
	12' - 14'	3☒Ⓞ207014R**	540 lbs	32
	14' - 16'	3☒Ⓞ207016R**	589 lbs	36
	16' - 18'	3☒Ⓞ207018R**	637 lbs	40
	18' - 20'	3☒Ⓞ207020R**	686 lbs	44
	20' - 22'	3☒Ⓞ207022R**	735 lbs	48
	22' - 24'	3☒Ⓞ207024R**	785 lbs	52
	24' - 26'	3☒Ⓞ207026R**	834 lbs	56
	26' - 28'	3☒Ⓞ207028R***	946 lbs	60
28' - 30'	3☒Ⓞ207030R***	1020 lbs	66	
7' HEIGHT	4' - 6'	3☒Ⓞ208206R*	314 / 318†	16
	6' - 8'	3☒Ⓞ208208R*	367 / 372†	20
	8' - 10'	3☒Ⓞ208210R*	420 / 426†	24
	10' - 12'	3☒Ⓞ208212R*	474 / 481†	28
	12' - 14'	3☒Ⓞ208214R**	605 / 613†	32
	14' - 16'	3☒Ⓞ208216R**	658 / 667†	36
	16' - 18'	3☒Ⓞ208218R**	711 / 721†	40
	18' - 20'	3☒Ⓞ208220R**	765 / 775†	44
	20' - 22'	3☒Ⓞ208222R**	818 / 830†	48
	22' - 24'	3☒Ⓞ208224R**	872 / 885†	52
	24' - 26'	3☒Ⓞ208226R**	926 / 940†	56
	26' - 28'	3☒Ⓞ208228R***	1055 / 1070†	60
28' - 30'	3☒Ⓞ208230R***	1135 / 1151†	66	

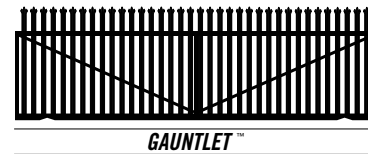
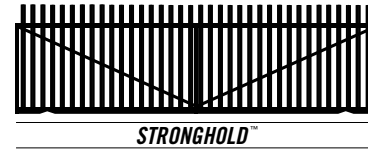
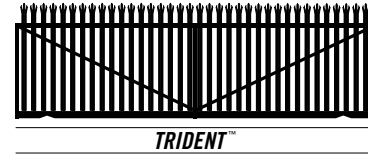

8' HEIGHTS ON FOLLOWING PAGE

Note: All gates that exceed 194" in length for Gauntlet and all 8' gates that exceed 194" in length for Trident & Stronghold will have bolt-on panels with face-welded pales.

Effective: 08/14/18



PASSPORT IS® | 2-RAIL ROLL GATES

POSTS & HARDWARE SOLD SEPARATELY | OPENINGS OVER 30' HAVE A 2-PIECE FRAME

OPENING	LENGTH	ITEM NUMBER	WEIGHT	PALE QTY
4' - 6'	98"	3   209406R*	348 / 352†	16
6' - 8'	122"	3   209408R*	406 / 410†	20
8' - 10'	146"	3   209410R*	464 / 469†	24
10' - 12'	170"	3   209412R*	522 / 529†	28
12' - 14'	194"	3   209414R**	670 / 678†	32
14' - 16'	218"	3   209416R**	728 / 736†	36
16' - 18'	242"	3   209418R**	785 / 795†	40
18' - 20'	266"	3   209420R**	843 / 854†	44
20' - 22'	290"	3   209422R**	902 / 913†	48
22' - 24'	314"	3   209424R**	960 / 973†	52
24' - 26'	338"	3   209426R**	1019 / 1032†	56
26' - 28'	362"	3   209428R***	1165 / 1180†	60
28' - 30'	398"	3   209430R***	1252 / 1268†	66

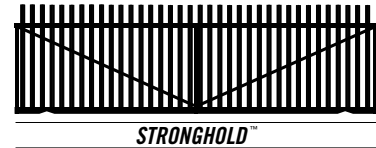
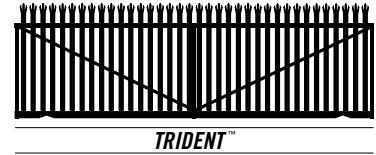
8'
HEIGHT



 = FENCE STYLES AVAILABLE | T = Trident S = Stronghold G = Gauntlet†
 = COLOR OPTIONS AVAILABLE | B = Black N = Bronze W = White S = Sand

Note: All gates that exceed 194" in length for Gauntlet and all 8' gates that exceed 194" in length for Trident & Stronghold will have bolt-on panels with face-welded pales.

* 2-Bays | ** 4-Bays | *** 6-Bays

Effective: 08/14/18

PASSPORT IS® | 3-RAIL ROLL GATES

POSTS & HARDWARE SOLD SEPARATELY | OPENINGS OVER 30' HAVE A 2-PIECE FRAME

OPENING	LENGTH	ITEM NUMBER	WEIGHT	PALE QTY	
6' HEIGHT	4' - 6'	98"	3☒Ⓞ307006R*	305 lbs	16
	6' - 8'	122"	3☒Ⓞ307008R*	359 lbs	20
	8' - 10'	146"	3☒Ⓞ307010R*	415 lbs	24
	10' - 12'	170"	3☒Ⓞ307012R*	470 lbs	28
	12' - 14'	194"	3☒Ⓞ307014R**	589 lbs	32
	14' - 16'	218"	3☒Ⓞ307016R**	644 lbs	36
	16' - 18'	242"	3☒Ⓞ307018R**	699 lbs	40
	18' - 20'	266"	3☒Ⓞ307020R**	754 lbs	44
	20' - 22'	290"	3☒Ⓞ307022R**	809 lbs	48
	22' - 24'	314"	3☒Ⓞ307024R**	864 lbs	52
	24' - 26'	338"	3☒Ⓞ307026R**	920 lbs	56
	26' - 28'	362"	3☒Ⓞ307028R***	1038 lbs	60
28' - 30'	398"	3☒Ⓞ307030R***	1121 lbs	66	
7' HEIGHT	4' - 6'	98"	3☒Ⓞ308206R*	339 / 343†	16
	6' - 8'	122"	3☒Ⓞ308208R*	398 / 403†	20
	8' - 10'	146"	3☒Ⓞ308210R*	458 / 463†	24
	10' - 12'	170"	3☒Ⓞ308212R*	518 / 524†	28
	12' - 14'	194"	3☒Ⓞ308214R**	654 / 662†	32
	14' - 16'	218"	3☒Ⓞ308216R**	713 / 722†	36
	16' - 18'	242"	3☒Ⓞ308218R**	773 / 782†	40
	18' - 20'	266"	3☒Ⓞ308220R**	832 / 843†	44
	20' - 22'	290"	3☒Ⓞ308222R**	892 / 904†	48
	22' - 24'	314"	3☒Ⓞ308224R**	952 / 964†	52
	24' - 26'	338"	3☒Ⓞ308226R**	1012 / 1026†	56
	26' - 28'	362"	3☒Ⓞ308228R***	1147 / 1162†	60
28' - 30'	398"	3☒Ⓞ308230R***	1237 / 1253†	66	



TRIDENT™

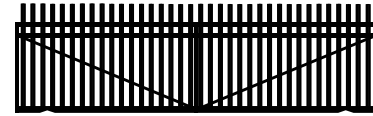

STRONGHOLD™



GAUNTLET™



8' HEIGHTS ON FOLLOWING PAGE

Note: All gates that exceed 194" in length for Gauntlet and all 8' gates that exceed 194" in length for Trident & Stronghold will have bolt-on panels with face-welded pales.

Effective: 08/14/18

PASSPORT IS® | 3-RAIL ROLL GATES

POSTS & HARDWARE SOLD SEPARATELY | OPENINGS OVER 30' HAVE A 2-PIECE FRAME

OPENING	LENGTH	ITEM NUMBER	WEIGHT	PALE QTY
4' - 6'	98"	3☒☉309406R*	373 / 377†	16
6' - 8'	122"	3☒☉309408R*	437 / 441†	20
8' - 10'	146"	3☒☉309410R*	501 / 507†	24
10' - 12'	170"	3☒☉309412R*	565 / 572†	28
12' - 14'	194"	3☒☉309414R**	719 / 727†	32
14' - 16'	218"	3☒☉309416R**	783 / 792†	36
16' - 18'	242"	3☒☉309418R**	847 / 857†	40
18' - 20'	266"	3☒☉309420R**	911 / 922†	44
20' - 22'	290"	3☒☉309422R**	975 / 987†	48
22' - 24'	314"	3☒☉309424R**	1040 / 1052†	52
24' - 26'	338"	3☒☉309426R**	1105 / 1118†	56
26' - 28'	362"	3☒☉309428R***	1257 / 1272†	60
28' - 30'	398"	3☒☉309430R***	1353 / 1369†	66

8'
HEIGHT

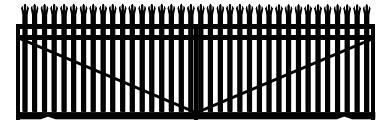

TRIDENT™

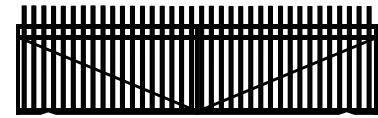

STRONGHOLD™

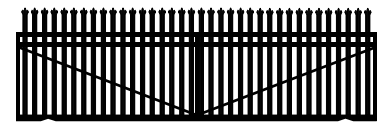

GAUNTLET™

← 8% →



☒ = FENCE STYLES AVAILABLE | T = Trident S = Stronghold G = Gauntlet†

☉ = COLOR OPTIONS AVAILABLE | B = Black N = Bronze W = White S = Sand

Note: All gates that exceed 194" in length for Gauntlet and all 8' gates that exceed 194" in length for Trident & Stronghold will have bolt-on panels with face-welded pales.

* 2-Bays | ** 4-Bays | *** 6-Bays

Effective: 08/14/18

PASSPORT IS® | HARDWARE

V-TRACK NOT INCLUDED

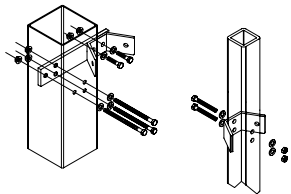

DESCRIPTION	ITEM NUMBER	WHEEL QTY	BOX QTY	WEIGHT
PassPort Gate Kit	PGKODN	2	1	35

Kits include: (2) 6" Wheel Kits / includes wheels, bearings, spacer bushings, washers, bolts & lock nuts | (2) Safety Guide Rollers | (1) Gate Latch

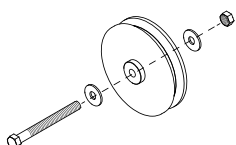
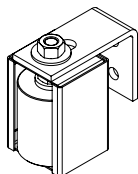

PASSPORT IS® | ORNAMENTAL SQUARE POST

DESCRIPTION	POST LENGTH	ITEM NUMBER	POST WEIGHT
4" sq. x 11ga. STEEL	6'	P⊗ 40072	39 lbs
	7'	P⊗ 40084	47 lbs
	8'	P⊗ 40096	54 lbs
	9'	P⊗ 40108	61 lbs
	10'	P⊗ 40120	67 lbs
	11'	P⊗ 40132	74 lbs
	12'	P⊗ 40144	81 lbs
	13'	P⊗ 40156	87 lbs
	14'	P⊗ 40168	94 lbs
	15'	P⊗ 40180	101 lbs
	16'	P⊗ 40192	108 lbs

⊗ = COLOR OPTIONS AVAILABLE | **B** = Black **N** = Bronze **W** = White **S** = Sand

Effective: 08/14/18

PASSPORT IS® | STEEL PLATED ORNAMENTAL SQUARE POSTS

PLATED POSTS USED WITH MAJESTIC PANELS REQUIRE 1" DEPENDING ON GRADE ELEVATION

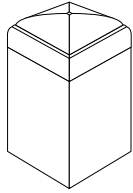

STEEL POSTS

4"sq. x 11ga.

POST LENGTH	PLATE SIZE	ITEM NUMBER	WEIGHT
4'	8" sq. x .375" / .5625" holes (8876G)	P⊗40048P	33 lbs
5'	8" sq. x .375" / .5625" holes (8876G)	P⊗40060P	39 lbs
6'	8" sq. x .375" / .5625" holes (8876G)	P⊗40072P	47 lbs
7'	8" sq. x .375" / .5625" holes (8876G)	P⊗40084P	54 lbs
8'	8" sq. x .375" / .5625" holes (8876G)	P⊗40096P	61 lbs
9'	8" sq. x .375" / .5625" holes (8876G)	P⊗40108P	67 lbs
10'	8" sq. x .375" / .5625" holes (8876G)	P⊗40120P	74 lbs

⊗ = COLOR OPTIONS AVAILABLE | **B** = Black **N** = Bronze **S** = Sand **W** = White

PASSPORT IS® | POST CAPS

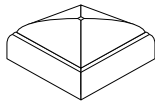

STANDARD FLAT CAP
Steel

CAP SIZE	ITEM NUMBER	WEIGHT
4"sq.	A⊗509	.4 lbs

⊗ = COLOR OPTIONS AVAILABLE | **B** = Black **N** = Bronze **S** = Sand **W** = White

Effective: 08/14/18

PASSPORT IS® | CONSTRUCTION SPECIFICATION 32 31 00

STEEL ROLL GATE SYSTEM

PART 1 - GENERAL

1.01 WORK INCLUDED

The contractor shall provide all labor, materials and appurtenances necessary for installation of the steel roll gate system defined herein at (*specify project site*).

1.02 RELATED WORK

Section 022__ - Earthwork

Section 030__ - Concrete

1.03 SYSTEM DESCRIPTION

The manufacturer shall supply a total roll gate system of Ameristar® PassPort IS® (*Impasse™ Security*) design series and (*specify Trident™, Stronghold™, or Gauntlet™*) style. The system shall include all components (*i.e., pales, rails, gate uprights, wheels and hardware*) required.

1.04 QUALITY ASSURANCE

The contractor shall provide laborers and supervisors who are thoroughly familiar with the type of construction involved and materials and techniques specified.

1.05 REFERENCES

- **ASTM B117** – Practice for Operating Salt-Spray (Fog) Apparatus
- **ASTM D523** – Test Method for Specular Gloss
- **ASTM D714** – Test Method for Evaluating Degree of Blistering in Paint
- **ASTM D1654** – Test Method for Evaluation of Painted or Coated Specimens Subjected to Corrosive Environments
- **ASTM D2244** – Test Method for Calculation of Color Differences from Instrumentally Measured Color Coordinates
- **ASTM D2794** – Test Method for Resistance of Organic Coatings to the Effects of Rapid Deformation (Impact)
- **ASTM D3359** – Test Method for Measuring Adhesion by Tape Test
- **ASTM D6695** – Standard Practice for Xenon-Arc Exposures of Paint and Related Coatings

1.06 SUBMITTAL

The manufacturer's submittal package shall be provided prior to installation.

1.07 PRODUCT HANDLING AND STORAGE

Upon receipt at the job site, all materials shall be checked to ensure that no damages occurred during shipping or handling. Materials shall be stored in such a manner to ensure proper ventilation and drainage and to protect against damage, weather, vandalism and theft.

PART 2 - MATERIALS

2.01 MANUFACTURER

The steel roll gate system shall conform to Ameristar PassPort IS (*Impasse Security*) design series, (*specify Trident, Stronghold, or Gauntlet*) style and (*specify 2-rail or 3-rail*) frame configuration manufactured by Ameristar Fence Products, Inc. in Tulsa, Oklahoma.

2.02 MATERIAL

- A. Steel material for roll gate components (*i.e.* pickets or pales, rails, diagonals and uprights), shall be commercial steel with minimum yield strength of 45,000 psi (344 MPa).
- B. Ornamental pale material shall be 2-3/4" wide x 0.075" thick corrugated pales. Pale spacing shall be 6". Material for top rails, uprights and diagonals rails shall be 2" square x 12ga. Material for the bottom rail shall be 2" x 4" x 11ga. Posts shall be a minimum of 4" square x 11ga.

2.03 FABRICATION

- A. Pickets/pales, rails, uprights and posts shall be pre-cut to specified lengths. Diagonals shall be pre-cut to specified lengths and angles. Frame materials shall be joined by welding. Pickets/pales shall be face welded to roll gate frame, except for *Invincible™* or *Gauntlet* style gates over 18' long. *Invincible* or *Gauntlet* style gates over 18' long shall have pickets face-welded to 2" x 2" angle iron to form panels equal in length to the gate frame bay width.
- B. The manufactured roll gates and bolt-on panels (**if applicable**) shall be subjected to the PermaCoat® thermal stratification coating process (*high-temperature, in-line, multi-stage, multi-layer*) including, as a minimum, a six-stage pre-treatment/wash, an electrostatic spray application of an epoxy base, and a separate electrostatic spray application of a polyester finish. The base coat shall be a thermosetting epoxy powder coating (*gray in color*) with a minimum thickness of 2 mils (0.0508mm). The topcoat shall be a "no-mar" TGIC polyester powder coat finish with a minimum thickness of 2 mils (0.0508mm). The color shall be (*specify Black, Bronze, White, or Desert Sand*). The stratification-coated framework shall be capable of meeting the performance requirements for each quality characteristic shown in **Table 1**.
- C. Completed gates shall be capable of supporting a 200 lb. load applied at midspan without permanent deformation.

Effective: 08/14/18

AMERISTAR

ASSA ABLOY

TO PLACE YOUR ORDER CALL 888-333-3422 | VISIT AMERISTARFENCE.COM

PASSPORT IS® | CONSTRUCTION SPECIFICATION 32 31 00

STEEL ROLL GATE SYSTEM

PART 3 - EXECUTION

3.01 PREPARATION

All new installation shall be laid out by the contractor in accordance with the construction plans.

3.02 INSTALLATION

Gate posts shall be set in accordance with the spacings shown in the construction plans. The "Earthwork" and "Concrete" sections of this specification shall govern post base material requirements. 6" wheels shall be bolted to the gate (*between the wheel plates welded near the ends of the gate bottom rail*). The gate shall be set upright with the V-grooved wheels positioned over the pre-installed steel V-track that traverses the gate opening. Roller guides shall be affixed to the gate posts at a height even with the gate toprail to hold the gate in a vertical position. Gate stops shall be welded to the end of the gate or track so gate cannot pass rollers in either direction.

3.03 CLEANING

The contractor shall clean the jobsite of excess materials; post hole excavations shall be scattered uniformly away from posts.

TABLE 1

COATING PERFORMANCE REQUIREMENTS		
QUALITY CHARACTERISTICS	ASTM TEST METHOD	PERFORMANCE REQUIREMENTS
ADHESION	D3359 – METHOD B	Adhesion (<i>retention of coating</i>) over 90% of test area (<i>tape and knife kit test</i>).
CORROSION RESISTANCE	B117, D714, D1654	Corrosion resistance over 1,000 hours (<i>scribed per D1654; failure mode is accumulation of 1/8" coating loss from scribe or medium #8 blisters</i>)
IMPACT RESISTANCE	D2794	Impact resistance over 60" lb. (<i>forward impact using 0.625" ball</i>).
WEATHERING RESISTANCE	D822 D2244, D523 (60° method)	Weathering resistance over 1,000 hours (<i>failure mode is 60% loss of gloss or color variance of more than 3 delta-E color units</i>).

Effective: 08/14/18

Effective: 08/14/18

Effective: 08/14/18

Effective: 08/14/18