

JUST ASK FOR THE

MAXIMA[®] TRADITIONAL

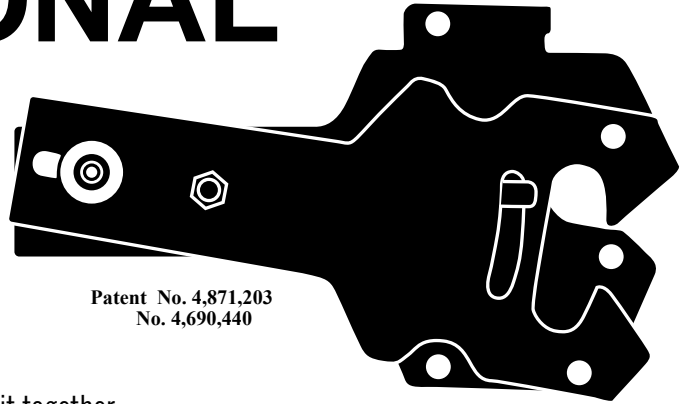

Patent No. 4,871,203
No. 4,690,440

QUICK & EASY TO INSTALL

- **PRE-ASSEMBLED** – You do not have to put it together
- **EASIEST INSTALLATION** – Two piece latch assembly mounts quickly with two fasteners
- **NO SPRINGS** – Simplifies installation/operation... eliminates lost or missing spring problems
- **ONE-STEP REVERSIBILITY** – Just flip it over... no disassembly or reassembly required
- **SUPPORTED STRIKER BAR** – Handle adds stability to gate mounted striker

AVOID TYPICAL INSTALLATION PROBLEMS

- **ANTI-SAG DESIGN** – Forces gate striker to catch
- **POSITIVE GATE SUPPORT** – Provides complete upward support on latch side
- **NO SMALL REPLACEMENT PARTS NEEDED** – Eliminates need for replacing springs or assembly screws
- **EXTRA HEAVY DUTY** – 11 gauge steel mainframe and keeper; 3/4" diameter striker

END USER SATISFACTION

- **PADLOCKS ON EITHER SIDE** – For any gate/post framing thickness
- **"SLIP-LOCK"** – Solid brass button enables manual locking back side
- **SAFETY CONTOUR** – No protruding points to cause accidental injury
- **HIGH SECURITY** – Positive capture feature of keeper and catch makes release of striker impossible when latch is locked
- **POWDER-COATED FINISH** – Withstands the elements

Effective: 01/01/18

MAXIMA® TRADITIONAL STYLE | GATE LATCHES

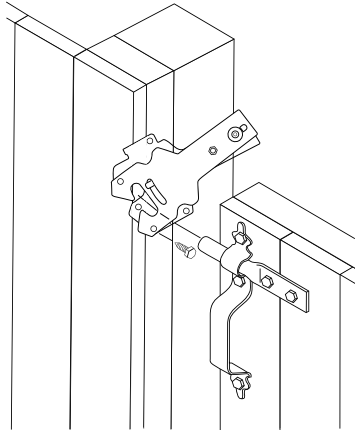

DESCRIPTION	ITEM NUMBER	FINISH	HANDLE	BOX QTY	BOX WEIGHT	STOCKING
Maxima® Deluxe Latch Set with Slip-Lock	296-SX-R	BLACK	✓	20	49 lbs	✓

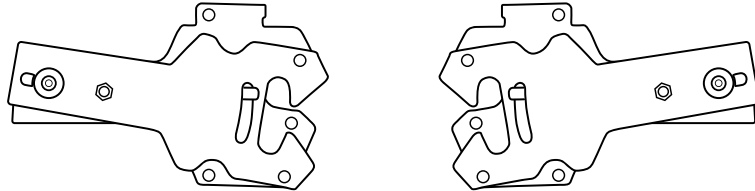

The "Max" deluxe latch set includes striker, handle, slip-lock & screws | Reversible without disassembly

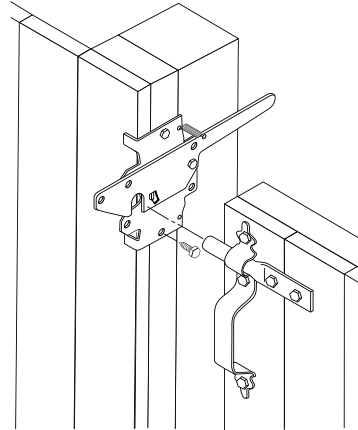

DESCRIPTION	ITEM NUMBER	FINISH	HANDLE	BOX QTY	BOX WEIGHT	STOCKING
Maxima® Post Latch	210-SX-R	BLACK	⊘	20	33 lbs	✓
	210-SHX-R	BLACK	✓	20	39 lbs	✓

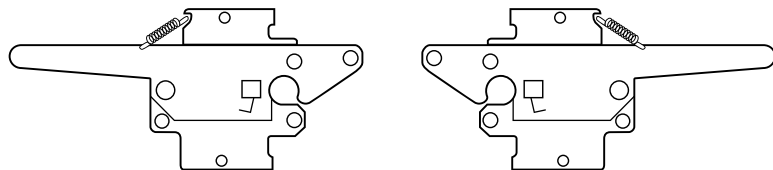

Heavy duty post latch for both single & double gates | Self-latching works from right or left | Can be locked from both sides | Reversible by removing the bolt shoulder bolt & spring, reversing the paddle & re-inserting the bolt & spring

Effective: 01/01/18

MAXIMA® TRADITIONAL STYLE | HINGES

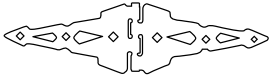

DESCRIPTION	ITEM NUMBER	FINISH	PACKAGING	BOX QTY	BOX WEIGHT	STOCKING
Maxima® 8" Strap Hinge	130-SX-R	BLACK	☉	20 pr	61 lbs	✓

4.75" Hinge Pin for additional width | 12 ga. Steel | 5" height | 16" length | Non-sag design

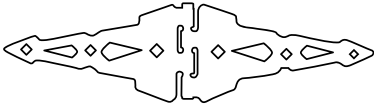

Maxima® 10" Strap Hinge	132-SX-R	BLACK	☉	20 pr	72 lbs	✓
-------------------------	----------	-------	---	-------	--------	---

4.75" Hinge Pin for additional width | 12 ga. Steel | 5" height | 20" length | Non-sag design

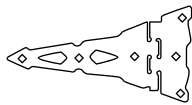

Maxima® 8" Tee Hinge	134-SX-R	BLACK	☉	20 pr	53 lbs	✓
----------------------	----------	-------	---	-------	--------	---

4.75" Hinge Pin for additional width | 12 ga. Steel | 7.25" height | 10.5" length

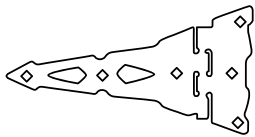

Maxima® 10" Tee Hinge	136-SX-R	BLACK	☉	20 pr	60 lbs	✓
-----------------------	----------	-------	---	-------	--------	---

4.75" Hinge Pin for additional width | 12 ga. Steel | 7.25" height | 13" length

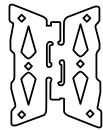

Maxima® 8" Butterfly Hinge	138-SX-R	BLACK	☉	20 pr	47 lbs	✓
----------------------------	----------	-------	---	-------	--------	---

4.75" Hinge Pin for additional width | 12 ga. Steel | 7.25" height | 4.5" length | Ideal for narrow mounting space allowance

☐ = BULK / BOXED LOOSE WITHOUT SCREWS | ☑ = BULK / BOXED LOOSE WITH SCREWS (in separate bulk package)

⦿ = INDIVIDUALLY WRAPPED (polybag) WITHOUT SCREWS | ⦿ = INDIVIDUALLY WRAPPED (polybag) WITH SCREWS

⊖ = NON-STOCKED PRODUCT: For details, see Ameristar's Sales Policy in the catalog guide.

✓ = STOCKED PRODUCT: For details, see Ameristar's Sales Policy in the catalog guide.

Effective: 01/01/18

MAXIMA® TRADITIONAL STYLE | DELUXE LATCH WALK GATE SETS

SINGLE WALK SETS

DESCRIPTION	SIZE	ITEM NUMBER	FINISH	PACKAGING	BOX QTY	BOX WEIGHT	STOCKING
Two-Hinge Walk Sets	(2) 8" Strap	430-P/BX-R	BLACK	☉	8 sets	44 lbs	✓
	(2) 8" Tees	431-P/BX-R	BLACK	☉	8 sets	41 lbs	⊘

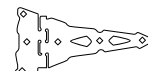
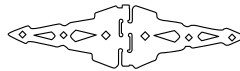
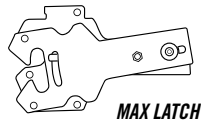

Complete kit for 1 walk gate.

DOUBLE WALK SETS

DESCRIPTION	SIZE	ITEM NUMBER	FINISH	PACKAGING	BOX QTY	BOX WEIGHT	STOCKING
Double Drive Walk Gate Sets	(4) 10" Straps	483X-R	BLACK	☉	6 sets	78 lbs	✓

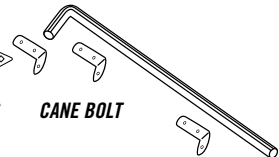
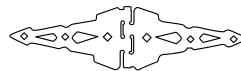
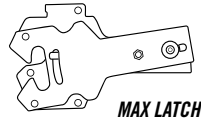

Complete kit for 1 double drive gate.

☐ = BULK / BOXED LOOSE WITHOUT SCREWS | ☑ = BULK / BOXED LOOSE WITH SCREWS (in separate bulk package)

☉ = INDIVIDUALLY WRAPPED (polybag) WITHOUT SCREWS | ☉ = INDIVIDUALLY WRAPPED (polybag) WITH SCREWS

⊘ = NON-STOCKED PRODUCT: For details, see Ameristar's Sales Policy in the catalog guide.

✓ = STOCKED PRODUCT: For details, see Ameristar's Sales Policy in the catalog guide.

Effective: 01/01/18

MAXIMA® TRADITIONAL STYLE | POST LATCH WALK GATE SETS

SINGLE WALK SETS

DESCRIPTION	SIZE	ITEM NUMBER	FINISH	PACKAGING	BOX QTY	BOX WEIGHT	STOCKING
Two-Hinge Walk Sets	(2) 8" Strap	410-PBX-R	BLACK	☉	8 sets	41 lbs	✓
	(2) 8" Tees	411-PBX-R	BLACK	☉	8 sets	37 lbs	✓
Three-Hinge Walk Sets	(3) 8" Strap	419-PBX-R	BLACK	☉	8 sets	52 lbs	✓

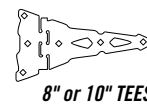
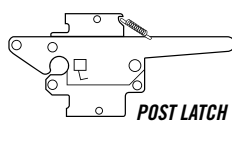

Complete kit for 1 walk gate.

DOUBLE WALK SETS

DESCRIPTION	SIZE	ITEM NUMBER	FINISH	PACKAGING	BOX QTY	BOX WEIGHT	STOCKING
Double Drive Walk Gate Sets	(4) 8" Strap	461X-R	BLACK	☉	6 sets	69 lbs	✓
	(4) 10" Straps	463X-R	BLACK	☉	6 sets	75 lbs	✓

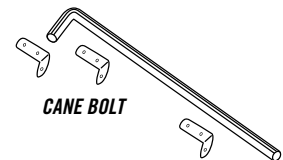
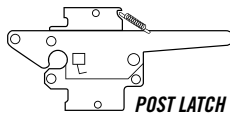

Complete kit for 1 double drive gate.

☐ = BULK / BOXED LOOSE WITHOUT SCREWS | ☑ = BULK / BOXED LOOSE WITH SCREWS (in separate bulk package)

☉ = INDIVIDUALLY WRAPPED (polybag) WITHOUT SCREWS | ☉ = INDIVIDUALLY WRAPPED (polybag) WITH SCREWS

⊖ = NON-STOCKED PRODUCT: For details, see Ameristar's Sales Policy in the catalog guide.

✓ = STOCKED PRODUCT: For details, see Ameristar's Sales Policy in the catalog guide.

Effective: 01/01/18

CONTINENTAL STYLE | GATE LATCHES & HINGES

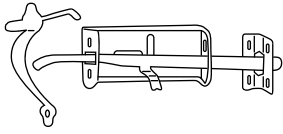

DESCRIPTION	SIZE	ITEM NUMBER	FINISH	PACKAGING	BOX QTY	BOX WEIGHT	STOCKING
Continental Thumb Latch	5" lever	220X-R	BLACK	☉	20 ea	29 lbs	✓

For single swing ingress gates | Self latching & reversible
Latch not recommended for pool gates



Continental 8" Strap Hinge	8"	116-SX-R	BLACK	☉	20 pr	56 lbs	✓
-----------------------------------	----	----------	-------	---	-------	--------	---

For walk gates or double drive gates up to 10' opening | Slim profile

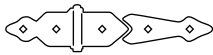

Continental 8" Half-Strap Hinge	8"	126-SX-R	BLACK	☉	20 pr	47 lbs	✓
--	----	----------	-------	---	-------	--------	---

For walk gates or double drive gates up to 10' opening | Slim profile

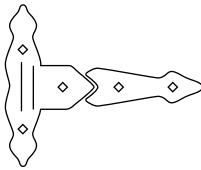

Continental Tee Hinges	8"	101-SPX-R*	BLACK	☉	20 pr	49 lbs	✓
	8"	101-SX-R	BLACK	☉	20 pr	48 lbs	✓
	12"	104-SX-R	BLACK	☉	5 pr	29 lbs	✓

*INCLUDES 3" fastener | 8" Tee Hinge = 7.75" x 9" | 12" Tee Hinge = 10" 14.875"

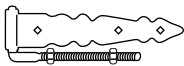

Continental Bolt Hook & Strap Hinge	8" x 12"	146-SX-R	BLACK	☉	10 pr	54 lbs	⊖
--	----------	----------	-------	---	-------	--------	---

8" Strap Hinge = .5" x 2" x 7" | 12" Strap Hinge = .625" x 2" x 8"

☐ = BULK / BOXED LOOSE WITHOUT SCREWS | ☑ = BULK / BOXED LOOSE WITH SCREWS (in separate bulk package)

⊙ = INDIVIDUALLY WRAPPED (polybag) WITHOUT SCREWS | ☉ = INDIVIDUALLY WRAPPED (polybag) WITH SCREWS

⊖ = NON-STOCKED PRODUCT: For details, see Ameristar's Sales Policy in the catalog guide.

✓ = STOCKED PRODUCT: For details, see Ameristar's Sales Policy in the catalog guide.

Effective: 01/01/18

UNIVERSAL STYLE | GATE LATCHES & HINGES

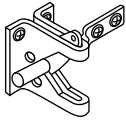

DESCRIPTION	SIZE	ITEM NUMBER	FINISH	PACKAGING	BOX QTY	BOX WEIGHT	STOCKING
Universal Gravity Latch	5"	232X-R	BLACK	☉	50 ea	23 lbs	✓

Self latching | Reversible

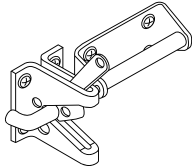

Universal Heavy-duty Gravity Latch	n/a	276X-R	BLACK	☉	20 ea	30 lbs	✓
	n/a	276-SPX-R*	BLACK	☉	20 ea	31 lbs	✓
	n/a	278X-R	ZINC	☉	20 ea	30 lbs	✓

**Includes pull cable & ring*

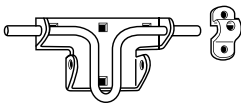

Universal Slide Bolt Latch	n/a	241X-R	BLACK	☉	30 ea	24 lbs	✓
-----------------------------------	-----	--------	-------	---	-------	--------	---

Multi-purpose latch with slide bolt action that can be positioned for use with a padlock | Ingress or egress swing capabilities | Ideal for installation on garage doors

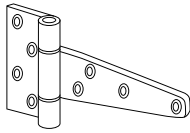

Universal 6" Tee Hinge	6"	190X-R	ZINC	☐	40 pr	50 lbs	✓
-------------------------------	----	--------	------	---	-------	--------	---

Economical hinge for smaller doors or walk gates | Simple to install

****All latches listed on this page are not recommended for pool gate applications****

Effective: 01/01/18

COLONIAL STYLE | GATE LATCHES & HINGES

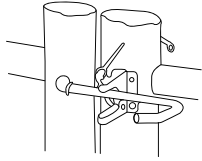

DESCRIPTION	SIZE	ITEM NUMBER	FINISH	PACKAGING	BOX QTY	BOX WEIGHT	STOCKING
Colonial All-purpose Gravity Latch	n/a	270X-R	ZINC	☉	20 ea	36 lbs	✓

Includes screws, pull cable & ring | Latch allows for unusual sag

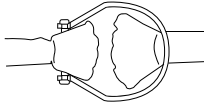

Colonial Split Rail Loop Latch	n/a	260X-R	ZINC	☉	30 ea	22 lbs	✓
--------------------------------	-----	--------	------	---	-------	--------	---

For use with split rail & stockade fence | Latch = .375" rod | 7" wide x 8.5" long | Fits fence posts up to 7" wide

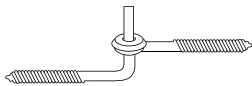

Colonial Screw Hook & Eye Hinge	.5" x 4"	161X-R	ZINC	○	30 pr	33 lbs	✓
	.625" x 5"	169X-R	ZINC	○	30 pr	62 lbs	✓

For round post & split rail gates | Includes: (2) Screw Eyes, (2) Screw Hooks

☐ = BULK / BOXED LOOSE WITHOUT SCREWS | ☑ = BULK / BOXED LOOSE WITH SCREWS (in separate bulk package)

○ = INDIVIDUALLY WRAPPED (polybag) WITHOUT SCREWS | ☉ = INDIVIDUALLY WRAPPED (polybag) WITH SCREWS

⊖ = NON-STOCKED PRODUCT: For details, see Ameristar's Sales Policy in the catalog guide.

✓ = STOCKED PRODUCT: For details, see Ameristar's Sales Policy in the catalog guide.

WOOD GATE HARDWARE | FASTENERS

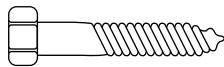

DESCRIPTION	SIZE	ITEM NUMBER	FINISH	QTY	BOX WEIGHT	STOCKING
Hex Head Lag Screws	.3125" x 2"	351P-200	BLACK	200	8 lbs	✓
	.3125" x 1.5"	352	BLACK	2,315	75 lbs	⊖
	.25" x 1.25"	353	BLACK	2,700	60 lbs	⊖
Carriage Bolts with Flange Nuts	.3125" x 3"	355	BLACK	1,000	67 lbs	⊖

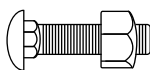

Effective: 01/01/18

WOOD GATE HARDWARE | COMPONENTS

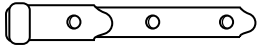

DESCRIPTION	SIZE	ITEM NUMBER	PACKAGING	FINISH	QTY	BOX WEIGHT	STOCKING
Heavy-duty Straps	10"	537X-R	☐	ZINC*	40 ea	32 lbs	✓

.625" diameter barrel | 8" strap has 2 holes | 10" has 3 holes

*ZINC finish is standard, but BLACK is available by special order



Screw Hooks	.625" x 5" x 1.25"	512X	⊙	ZINC*	60 ea	33 lbs	⊙
-------------	--------------------	------	---	-------	-------	--------	---

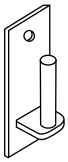

Plate Pintels	.625" x 1.25"	526X-R	☐	ZINC	40 ea	22 lbs	✓
---------------	---------------	--------	---	------	-------	--------	---

☐ = BULK / BOXED LOOSE WITHOUT SCREWS | ☐ = BULK / BOXED LOOSE WITH SCREWS (in separate bulk package)

⊙ = INDIVIDUALLY WRAPPED (polybag) WITHOUT SCREWS | ⊙ = INDIVIDUALLY WRAPPED (polybag) WITH SCREWS

⊙ = NON-STOCKED PRODUCT: For details, see Ameristar's Sales Policy in the catalog guide.

✓ = STOCKED PRODUCT: For details, see Ameristar's Sales Policy in the catalog guide.

Effective: 01/01/18

WOOD GATE HARDWARE | ACCESSORIES

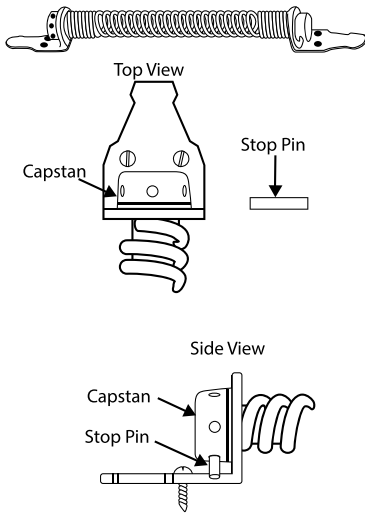

DESCRIPTION	ITEM NUMBER	FINISH	PACKAGING	BOX QTY	BOX WEIGHT	STOCKING
14" Gate Spring	331X	BLACK	☉	30 ea	39 lbs	✓

Notes: Fully adjustable for gate or door installations | Gate spring must be installed in an oblique position (as shown), with the adjustable capstan to the top & to the left when facing the gate face | Gate spring must be installed on the same side as the gate hinges | Increase tension in the spring by using a wrench pin at the top capstan, then turn counter-clockwise | Insert stop pin into capstan once desired tension has been achieved

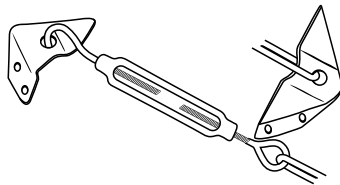
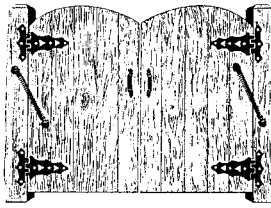

DESCRIPTION	ITEM NUMBER	FINISH	PACKAGING	BOX QTY	BOX WEIGHT	STOCKING
Gate Sag Prevention Kit	337X	ZINC	☉	30 ea	20 lbs	✓

Notes: Prevents sagging on NEW gates | Able to raise an EXISTING gate | Fits panels up to 6' high & 5' wide | Kit includes cable, brackets, tightener & screws | Future adjustments can be made by tightening the turnbuckle | Position from mid height on latch side to the top back rail on the hinge side | AVOID mounting from the bottom of the latch side as it may cause the gate to "bow"

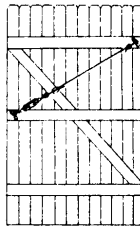

- ☐ = BULK / BOXED LOOSE WITHOUT SCREWS | ☑ = BULK / BOXED LOOSE WITH SCREWS (in separate bulk package)
- = INDIVIDUALLY WRAPPED (polybag) WITHOUT SCREWS | ⊙ = INDIVIDUALLY WRAPPED (polybag) WITH SCREWS
- ⊖ = NON-STOCKED PRODUCT: For details, see Ameristar's Sales Policy in the catalog guide.
- ✓ = STOCKED PRODUCT: For details, see Ameristar's Sales Policy in the catalog guide.

Effective: 01/01/18

WOOD GATE HARDWARE | ACCESSORIES

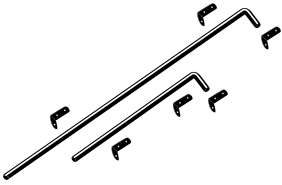

DESCRIPTION	SIZE	ITEM NUMBER	FINISH	PACKAGING	BOX QTY	BOX WEIGHT	STOCKING
Cane Bolt Sets	18"	313-BX-R	BLACK*	☐	10 ea	24 lbs	✓
	24"	315-BX-R	BLACK*	☐	10 ea	29 lbs	✓
	48"	316-BX-R	BLACK	☐	10 ea	50 lbs	✓
	30"	317-BX-R	BLACK	☐	10 ea	34 lbs	✓

* Available in Zinc finish / must specify
 For use on double gates & garage doors | .625" solid bar | 3 guides & hanger brackets | Screws INCLUDED

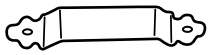

Standard Handle	6"	321-BX-R	BLACK	☐	200 ea	42 lbs	✓
	6"	322-BX-R	BLACK	⦿	200 ea	32 lbs	✓

For use with Post Latch #210-SX. 321-BX-R comes with 2 guides and 1 hanger bracket.



Ornamental Handle	9"	326X-R	BLACK	☐	60 ea	17 lbs	⊖
-------------------	----	--------	-------	---	-------	--------	---

Used in conjunction with Thumb Latch

☐ = BULK / BOXED LOOSE WITHOUT SCREWS | ☐ = BULK / BOXED LOOSE WITH SCREWS (in separate bulk package)

⦿ = INDIVIDUALLY WRAPPED (polybag) WITHOUT SCREWS | ⦿ = INDIVIDUALLY WRAPPED (polybag) WITH SCREWS

⊖ = NON-STOCKED PRODUCT: For details, see Ameristar's Sales Policy in the catalog guide.

✓ = STOCKED PRODUCT: For details, see Ameristar's Sales Policy in the catalog guide.

Effective: 01/01/18

Effective: 01/01/18