

WIREWORKS PLUS®



COMMERCIAL WELDED WIRE STEEL FENCE

The WireWorks Plus fence system is the *new standard in welded wire fencing*. With this product, Ameristar has a fence solution that will reduce dependency on chain link. WireWorks Plus provides *unobstructed visibility, aesthetics, and security* while delivering a *value added fencing solution*.



PRIMARY APPLICATIONS

- **Commercial Developments**
- **Parking Facilities**
- **Self Storage**
- **Parks & Recreation**
- **Schools & Universities**
- **Apartments (Multi-Family)**
- **Amusement Parks**
- **Healthcare Facilities**



FENCE PRODUCTS

AMERISTARFENCE.COM | 888-333-3422

ASSA ABLOY, the global leader in door opening solutions

AMERISTAR®

ASSA ABLOY

WIREWORKS PLUS®

COMMERCIAL WELDED WIRE STEEL FENCE

6ga WIRE PANELS / 3" V-FOLDS | 2"sq x 16ga & 2.5"sq x 16ga POSTS

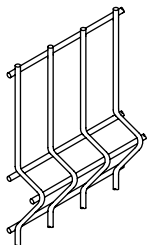

REINFORCED WELDED WIRE "V" FOLDS





Each WireWorks Plus panel has been designed with a series of architectural "V" folds, vital to the overall reinforcement and strength of the welded wire fence system. These fence panels are fabricated in a pattern of vertical and horizontal wires that are welded at each intersection. The unique design of WireWorks Plus provides strength and stability that is unmatched by typical chain link fence.

PERMACOAT™ PROTECTIVE FINISH



Ameristar's production facilities use a state-of-the-art polyester powder coating system that provides a durable and scratch resistant finish. WireWorks Plus is protected with Ameristar's PermaCoat multi-layer coating process. The combination of these layers delivers a system that increases weathering resistance and product durability. The Ameristar coating system results in finished surfaces with unmatched performance.



-  "No-Mar" Polyester Color Coat
-  Epoxy Powder Coat
-  Zinc Phosphate
-  Galvanized Steel



10 YEAR LIMITED WARRANTY

The family of WireWorks welded steel fencing products are manufactured from the highest quality materials by skilled craftsmen to meet the highest standards of workmanship in the industry. This is why Ameristar proudly offers a limited 10 year warranty.



FENCE PRODUCTS

TO PLACE YOUR ORDER CALL 888-333-3422

VISIT AMERISTARFENCE.COM

WIREWORKS PLUS® | 2, 3 & 4 ARCHITECTURAL V-FOLD OPTIONS*

*Depending on fence height

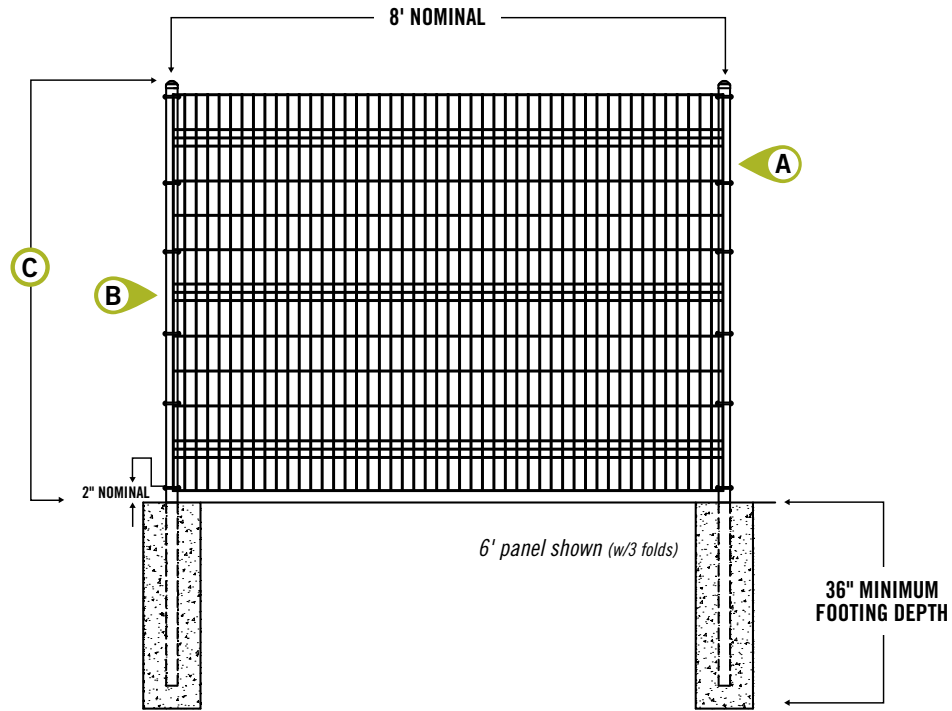

- A** 2"sq x 16ga / 2.5"sq x 16ga POST OPTIONS
- B** 2" X 6" MESH / 6ga WIRE
- C** 2/2/3/4 V-FOLDS (4'/5' /6'/8' heights respectively)
- D** 4', 5', 6' & 8' PANEL HEIGHT OPTIONS

*Refer to construction specification & tables
within this section for product details*

Effective: 01/01/18

WIREWOKS PLUS® | V-FOLD PANELS

8' PANEL LENGTH (96" actual width) | 2" w. x 6" h. MESH | 6 GAUGE WIRE

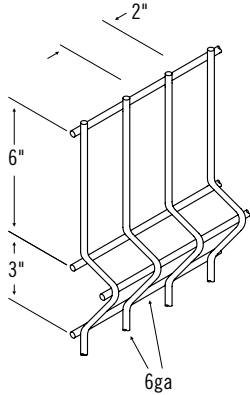

PANEL	ITEM NUMBER	WEIGHT	STOCKING
4'	5WPⓧ0408	30 lbs	⊙
5'	5WPⓧ0508	36 lbs	⊙
6'	5WPⓧ0608	43 lbs	⊙
8'	5WPⓧ0808	59 lbs	⊙

ⓧ = COLOR OPTIONS AVAILABLE | **B** = Black **G** = Green **N** = Bronze **S** = Sand

TB = Tube Brown **W** = White

⊙ = NON-STOCKED PRODUCT

For details, see Ameristar's Sales Policy in the catalog guide.

WIREWOKS PLUS® | V-FOLD BRACKETS

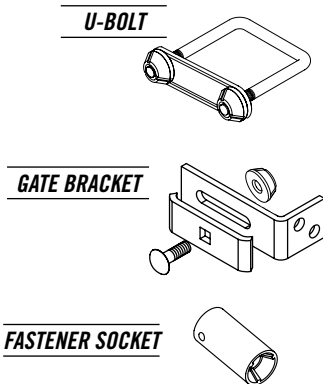

DESCRIPTION	SIZE	ITEM NUMBER	BOX QTY	WEIGHT EA	STOCKING
U-BOLT BRACKET FOR LINE / END POST	2"	UBⓧ2R	50	.5 lbs	⊙
	2.5"	UBⓧ25R	50	.8 lbs	⊙
	3"	UBⓧ3R	50	.9 lbs	⊙
	4"	UBⓧ4R	50	.9 lbs	⊙
CORNER / GATE BRACKET	N/A	WⓧGBSR	50	.9 lbs	⊙
FASTENER SOCKET	N/A	6-0058PFG	1	.06 lbs	⊙

ⓧ = COLOR OPTIONS AVAILABLE | **B** = Black **G** = Green **N** = Bronze **S** = Sand

TB = Tube Brown **W** = White

⊙ = NON-STOCKED PRODUCT

For details, see Ameristar's Sales Policy in the catalog guide.

Notes: 4' height require (3) brackets per post / 6' height require (5) brackets per post / 8' height require (7) brackets per post.

Effective: 01/01/18

AMERISTAR

ASSA ABLOY

TO PLACE YOUR ORDER CALL 888-333-3422 | VISIT AMERISTARFENCE.COM

WIREWORKS PLUS® | PANEL ACCESSORIES

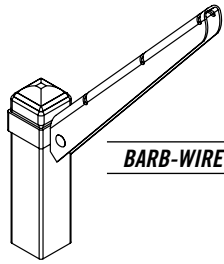

BARB-WIRE ARM KIT

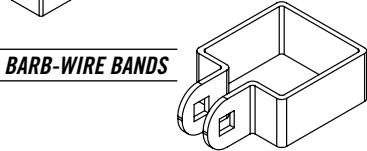

BARB-WIRE BANDS

DESCRIPTION	SIZE	ITEM NUMBER	BAG QTY	WEIGHT EA	STOCKING
BARB-WIRE ARM KIT*	2"	BWAB⊗2	1	---	⊙
	2.5"	BWAB⊗25	1	---	⊙

Each kit includes band, fasteners & barb arm blade.

NOTE: Allow 2 inches above panel for barb arm attachment.

BARB-WIRE BANDS**	2"	BWB⊗2R	3	---	⊙
	2.5"	BWB⊗25R	3	3 lbs	⊙

Each bag includes carriage bolts & Tri Groove Security Nuts.

NOTE: Allow a minimum of 14 inch post extension above the fence panel for barb-wire attachment.

⊗ = **COLOR OPTIONS AVAILABLE** | **B** = Black **G** = Green **N** = Bronze **S** = Sand **TB** = Tube Brown
W = White

⊙ = **NON-STOCKED PRODUCT**

For details, see Ameristar's Sales Policy in the catalog guide.

* Extend end, gate & corner posts to accommodate barb-wire arm attachment.

** Use barb-wire bands to attach barb-wire to end, gate & corner posts.

WIREWORKS PLUS® | CUSTOM FINISHES

WARRANTY ON RAILS CUT VOID WITHOUT PROPER APPLICATION OF ZINC RICH PRIMER & TOUCH-UP PAINT PENS

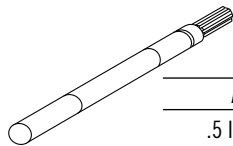

PAINT PEN

.5 lbs / P⊗100

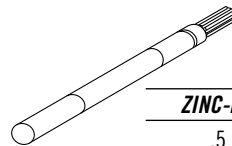

ZINC-RICH PAINT PEN

.5 lbs / PZ100

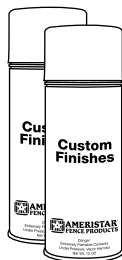

SPRAY PAINT

1.1 lbs / F⊗100

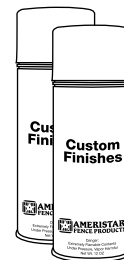

ZINC-RICH PRIMER

1.1 lbs / FZ100

⊗ = **COLOR OPTIONS AVAILABLE** | **B** = Black **N** = Bronze **W** = White **TB** = Tube Brown **S** = Sand **G** = Green

Effective: 01/01/18

WIREWOKS PLUS® | STEEL SQUARE POSTS

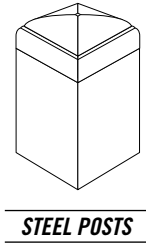

	POST LENGTH	ITEM NUMBER	WEIGHT
2"sq. x 16ga.	6' 9"	WP⊗ 20081	11 lbs
	7' 9"	WP⊗ 20093	13 lbs
	8' 9"	WP⊗ 20105	14 lbs
	10'	WP⊗ 20120	16 lbs
2.5"sq. x 16ga.	11'	WP⊗ 25132	22 lbs
	12'	WP⊗ 25144	24 lbs
2.5"sq. x 12ga.	6'	P⊗ 25072	19 lbs
	7'	P⊗ 25084	22 lbs
	8'	P⊗ 25096	26 lbs
	9'	P⊗ 25108	28 lbs
	10'	P⊗ 25120	31 lbs
	11'	P⊗ 25132	35 lbs
	12'	P⊗ 25144	36 lbs
3"sq. x 12ga.	6'	P⊗ 30072	24 lbs
	7'	P⊗ 30084	30 lbs
	8'	P⊗ 30096	34 lbs
	9'	P⊗ 30108	39 lbs
	10'	P⊗ 30120	43 lbs
	11'	P⊗ 30132	47 lbs
4"sq. x 11 ga.	12'	P⊗ 30144	51 lbs
	6'	P⊗ 40072	39 lbs
	7'	P⊗ 40084	47 lbs
	8'	P⊗ 40096	54 lbs
	9'	P⊗ 40108	61 lbs
	10'	P⊗ 40120	67 lbs
6"sq. x .1875" wall	11'	P⊗ 40132	74 lbs
	12'	P⊗ 40144	81 lbs
	7'	P⊗ 60084	102 lbs
	8'	P⊗ 60096	116 lbs
	9'	P⊗ 60108	131 lbs
	10'	P⊗ 60120	145 lbs
	11'	P⊗ 60132	160 lbs
	12'	P⊗ 60144	174 lbs

⊗ = COLOR OPTIONS AVAILABLE | **B** = Black **G** = Green
N = Bronze **S** = Sand
TB = Tube Brown **W** = White

Effective: 01/01/18

WIREWORKS PLUS® | STEEL PLATED SQUARE POSTS & POST CAPS

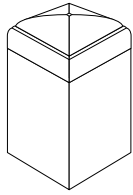

STEEL POSTS

2.5"sq. x 12ga.

POST LENGTH	PLATE SIZE	ITEM NUMBER	WEIGHT
4'	5" sq. x .25" / .5625" holes (8833G)	P⊗ 25048P	16 lbs
5'	5" sq. x .25" / .5625" holes (8833G)	P⊗ 25060P	19 lbs
6'	5" sq. x .25" / .5625" holes (8833G)	P⊗ 25072P	22 lbs
7'	5" sq. x .25" / .5625" holes (8833G)	P⊗ 25084P	26 lbs
8'	5" sq. x .25" / .5625" holes (8833G)	P⊗ 25096P	28 lbs
9'	5" sq. x .25" / .5625" holes (8833G)	P⊗ 25108P	31 lbs
10'	5" sq. x .25" / .5625" holes (8833G)	P⊗ 25120P	34 lbs
3"sq. x 12ga.			
4'	6" sq. x .25" / .5625" holes (5003G)	P⊗ 30048P	20 lbs
5'	6" sq. x .25" / .5625" holes (5003G)	P⊗ 30060P	24 lbs
6'	6" sq. x .25" / .5625" holes (5003G)	P⊗ 30072P	30 lbs
7'	6" sq. x .25" / .5625" holes (5003G)	P⊗ 30084P	34 lbs
8'	6" sq. x .25" / .5625" holes (5003G)	P⊗ 30096P	39 lbs
9'	6" sq. x .25" / .5625" holes (5003G)	P⊗ 30108P	43 lbs
10'	6" sq. x .25" / .5625" holes (5003G)	P⊗ 30120P	47 lbs
4"sq. x 11ga.			
4'	8" sq. x .375" / .5625" holes (8876G)	P⊗ 40048P	33 lbs
5'	8" sq. x .375" / .5625" holes (8876G)	P⊗ 40060P	39 lbs
6'	8" sq. x .375" / .5625" holes (8876G)	P⊗ 40072P	47 lbs
7'	8" sq. x .375" / .5625" holes (8876G)	P⊗ 40084P	54 lbs
8'	8" sq. x .375" / .5625" holes (8876G)	P⊗ 40096P	61 lbs
9'	8" sq. x .375" / .5625" holes (8876G)	P⊗ 40108P	67 lbs
10'	8" sq. x .375" / .5625" holes (8876G)	P⊗ 40120P	74 lbs

⊗ = COLOR OPTIONS AVAILABLE | **B** = Black **N** = Bronze **S** = Sand **W** = White

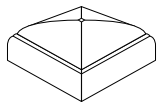

STANDARD FLAT CAP

Steel

CAP SIZE	ITEM NUMBER	WEIGHT
2.5"sq.	A⊗ 507	.3 lbs
3"sq.	A⊗ 508	.3 lbs
4"sq.	A⊗ 509	.4 lbs
6"sq.	A⊗ 515	.8 lbs
8"sq.	A⊗ 801	2 lbs

⊗ = COLOR OPTIONS AVAILABLE | **B** = Black **N** = Bronze **S** = Sand **W** = White

Effective: 01/01/18

WIREWORKS PLUS® | CONSTRUCTION SPECIFICATION 32 31 00

COMMERCIAL WELDED WIRE ARCHITECTURAL FENCE SYSTEM

PART 1 - GENERAL

1.01 WORK INCLUDED

The contractor shall provide all labor, materials and appurtenances necessary for installation of the commercial welded wire architectural fence system defined herein at (*specify project site*).

1.02 RELATED WORK

Section ____ - Earthwork

Section ____ - Concrete

1.03 SYSTEM DESCRIPTION

The manufacturer shall supply a total commercial welded wire architectural fence system of the Ameristar® WireWorks Plus® design. The system shall include all components (*i.e., panels, brackets, posts, gates and hardware*) required.

1.04 QUALITY ASSURANCE

The contractor shall provide laborers and supervisors who are thoroughly familiar with the type of construction involved and materials and techniques specified.

1.05 REFERENCES

- **ASTM A653/A653M** – Standard Specification for Steel Sheet, Zinc-Coated (Galvanized) or Zinc-Iron Alloy Coated (Galvannealed) by the Hot-Dip Process
- **ASTM B117** – Practice for Operating Salt-Spray (Fog) Apparatus
- **ASTM D523** – Test Method for Specular Gloss
- **ASTM D714** – Test Method for Evaluating Degree of Blistering in Paint
- **ASTM D1654** – Test Method for Evaluation of Painted or Coated Specimens Subjected to Corrosive Environments
- **ASTM D2244** – Test Method for Calculation of Color Differences from Instrumentally Measured Color Coordinates
- **ASTM D2794** – Test Method for Resistance of Organic Coatings to the Effects of Rapid Deformation (Impact)
- **ASTM D3359** – Test Method for Measuring Adhesion by Tape Test
- **ASTM D6695** – Standard Practice for Xenon-Arc Exposures of Paint and Related Coatings
- **ASTM F2453/F 2453M** – Standard Specification for Welded Wire Mesh Fence Fabric

1.06 SUBMITTAL

The manufacturer's submittal package shall be provided prior to installation.

1.07 PRODUCT HANDLING AND STORAGE

Upon receipt at the job site, all materials shall be checked to ensure that no damages occurred during shipping or handling. Materials shall be stored in such a manner to ensure proper ventilation and drainage, and to protect against damage, weather, vandalism and theft.

PART 2 - MATERIALS

2.01 MANUFACTURER

The fence system shall conform to Ameristar WireWorks Plus design by Ameristar Fence Products, Inc. in Tulsa, Oklahoma.

2.02 MATERIAL

- A.** Steel material for fence posts shall be galvanized prior to forming in accordance with the requirements of **ASTM A653/A653M**, with minimum yield strength of 45,000 psi (310 MPa). The steel shall be hot-dip galvanized to meet the requirements of **ASTM A653/A653M** with a minimum zinc coating weight of 0.60 oz/ft², Coating Designation G-60. Fence posts and gate posts shall meet the minimum size requirements of **Table 1**.
- B.** Steel wire mesh fence panels shall be welded by resistance welding per **ASTM A185** using 6 gauge (0.192") pre-galvanized steel wire, welded at each crossing to form rectangles. Vertical 6ga. (0.192") wires shall be spaced at 2"; horizontal 6ga. (0.192") wires shall be spaced at 6 inches. The cold rolled wire shall have a tensile strength of at least 70,000 PSI and 74,000 PSI weld shear strength. Wire strand shall be galvanized before welded (GBW), .050 ounces per square foot zinc coating conforming to the **ASTM A641**.

2.03 FABRICATION

- A.** Panels and posts shall be pre-cut to specified lengths. Panels shall have a number of structural folds based on the specified panel height as follows:
 1. 48" & 61" height x 96" width panel – 2 horizontal panel folds
 2. 69" height x 96" width panel – 3 horizontal panel folds
 3. 96" height x 96" width panel – 4 horizontal panel folds
- B.** The manufactured panels and posts shall be subjected to an inline electro-deposition coating (E-Coat) process consisting of a multi-stage pretreatment/wash, followed by a duplex application of an epoxy primer and an acrylic topcoat. The minimum cumulative coating thickness of epoxy and acrylic shall be 2 mils (0.058 mm). The color shall be (*specify Black or Bronze*). If color shall be (*specify White, Desert Sand, Green, or Tube Brown*) panels, posts,

Effective: 01/01/18

AMERISTAR

ASSA ABLOY

TO PLACE YOUR ORDER CALL 888-333-3422 | VISIT AMERISTARFENCE.COM

WIREWORKS PLUS® | CONSTRUCTION SPECIFICATION 32 31 00

COMMERCIAL WELDED WIRE ARCHITECTURAL FENCE SYSTEM

and brackets will undergo Ameristar PermaCoat coating process. The coated panels and posts shall be capable of meeting the performance requirements for each quality characteristic shown in **Table 2**.

- C. Swing gates shall be fabricated using 2" x 12ga square rails and gate ends. Gates that exceed 6' in width will have a 2" sq. x 12ga. intermediate upright. All rail, upright, and gate end intersections shall be joined by welding. Steel gussets (1/4" x 2") shall be welded at each rail to gate end intersection and rail to intermediate intersections (4 gussets per gate bay). Gusset shall be punched to accept gate trussing cable and turnbuckle.

dimensions and gate hardware selected. Type and quantity of gate hinges shall be based on the application; weight, height, and number of gate cycles. The manufacturers' gate drawings shall identify the necessary gate hardware required for the application. Gate hardware shall be provided by the manufacture of the gate and shall be installed per manufacturer's recommendations.

3.05 CLEANING

The contractor shall clean the jobsite of excess materials; post-hole excavations shall be scattered uniformly away from posts.

PART 3 - EXECUTION

3.01 PREPARATION

All new installation shall be laid out by the contractor in accordance with the construction plans.

3.02 FENCE INSTALLATION

Fence post shall be spaced according to **Table 3**, plus or minus ¼". Fence panels shall be attached to posts with brackets supplied by the manufacturer. Posts shall be set in concrete footers having a minimum depth of 36" (*Note: In some cases, local restrictions of freezing weather conditions may require a greater depth*). The "Earthwork" and "Concrete" sections of this specification shall govern material requirements for the concrete footer. Posts setting by other methods such as plated posts or grouted core-drilled footers are permissible only if shown by engineering analysis to be sufficient in strength for the intended application.

3.03 FENCE INSTALLATION MAINTENANCE

When cutting/drilling rails or posts adhere to the following steps to seal the exposed steel surfaces; 1) Remove all metal shavings from cut area. 2) Apply zinc-rich primer to thoroughly cover cut edge and/or drilled hole; let dry. 3) Apply 2 coats of custom finish paint matching fence color. Failure to seal exposed surfaces per steps 1-3 above will negate warranty. Ameristar spray cans or paint pens shall be used to prime and finish exposed surfaces; it is recommended that paint pens be used to prevent overspray. Use of non-Ameristar parts or components will negate the manufactures' warranty.

3.04 GATE INSTALLATION

Gate posts shall be spaced according to the manufacturers' gate drawings, dependent on standard out-to-out gate leaf

SEE REFERENCED TABLES ON THE FOLLOWING PAGE

Effective: 01/01/18

WIREWOKS PLUS® | CONSTRUCTION SPECIFICATION 32 31 00

COMMERCIAL WELDED WIRE ARCHITECTURAL FENCE SYSTEM

TABLE 1

MINIMUM SIZES FOR WIREWOKS PLUS POSTS		
FENCE POSTS	PANEL HEIGHTS	
2" x 16 ga.	up to 6' height	
2.5" x 16 ga.	8' height	

GATE LEAF	GATE HEIGHT	
	up to & including 6'	Over 6' and up to 8'
up to 4'	2½" x 12 gauge	3" x 12 gauge
4'1" to 6'	3" x 12 gauge	3" x 12 gauge
6'1" to 10'	4" x 11 gauge	6" x ¾"
10'1" to 16'	6" x ⅜"	6" x ⅜"

TABLE 2

COATING PERFORMANCE REQUIREMENTS		
QUALITY CHARACTERISTICS	ASTM TEST METHOD	PERFORMANCE REQUIREMENTS
ADHESION	D3359 – METHOD B	Adhesion (<i>retention of coating</i>) over 90% of test area (<i>tape and knife kit test</i>).
CORROSION RESISTANCE	B117, D714, D1654	Corrosion resistance over 1,000 hours (<i>scribed per D1654; failure mode is accumulation of 1/8" coating loss from scribe or medium #8 blisters</i>)
IMPACT RESISTANCE	D2794	Impact resistance over 60" lb. (<i>forward impact using 0.625" ball</i>).
WEATHERING RESISTANCE	D822 D2244, D523 (60° method)	Weathering resistance over 1,000 hours (<i>failure mode is 60% loss of gloss or color variance of more than 3 delta-E color units</i>).

TABLE 3

WIREWOKS PLUS POST SPACING BY BRACKET TYPE		
SPAN	WIREWOKS PLUS	
POST SIZE	2"	2½"
POST SETTINGS ± ¼" O.C.	96½"	96½"

Effective: 01/01/18

AMERISTAR

ASSA ABLOY

TO PLACE YOUR ORDER CALL 888-333-3422 | VISIT AMERISTARFENCE.COM

WIREWORKS PLUS® | LIMITED WARRANTY

COMMERCIAL WELDED WIRE FENCE

WireWorks Plus® Commercial Welded Wire Architectural Fence System by Ameristar® is manufactured from the highest quality materials by skilled craftsmen to meet the highest standards of workmanship in the industry. Galvanized steel framework shall be subject to a six stage pretreatment/wash followed by an electrostatic spray application of PermaCoat® Color System, a two coat powder system. The base coat is a thermosetting epoxy powder coating (*gray in color*). The top coat is a “no-mar” TGIC polyester powder coat finish, which provides the protection necessary to withstand adverse environmental conditions.

The powder coated surface on all framework (*i.e., panels, posts and brackets*) by Ameristar is guaranteed under normal and proper usage, against cracking, peeling, chipping, blistering or corroding for a period of ten (10) years from the original purchase date. Normal and proper usage does not include physical damage, abrasion or exposure to salty environments to the protective coating.

WireWorks Plus Commercial Welded Wire Architectural Fence System framework is also guaranteed for the same period of time against defects in workmanship or materials.

Should any architectural fence framework manufactured by Ameristar Fence Products fail in accordance with any of the above conditions, Ameristar Fence Products warrants to the original purchaser their redemption through replacement, renewal or issuance of a pro-rated credit. The decision as to which method of redemption is allowed is solely at the discretion of Ameristar. If pro-rated allowance is the chosen alternative, the amount will be based on the total number of years under warranty from date of purchase to date of claim, based on the original cost of framing materials found to be defective. Notice of failure under the conditions of this warranty shall be sent to Ameristar Fence Products or its authorized representative, in writing, together with proof of purchase and shall specify the nature of the defect and when it was first observed. When cutting WireWorks Plus products immediately seal the exposed surfaces by 1) Removing all metal shavings from cut area 2) Apply zinc-rich primer to thoroughly cover cut edge and drilled hole; let dry 3) Apply 2 coats of custom finish paint matching fence color. Failure to seal exposed surfaces per steps 1-3 above will negate warranty. If contractor uses non Ameristar parts/components this will negate the warranty. Should the fence be improperly installed, Ameristar Fence Products shall not be responsible for guaranteed performance or appearance of the material. Neither does this guarantee apply when failure or damage is due to improper use or application, abuse or misuse, salty environments, vandalism or acts of God. Ameristar Fence Products reserves the right to inspect the material to determine validity of the claim.

Upon validation of the claim by Ameristar Fence Products or its authorized representative, redemption by replacement, renewal or issuance of a pro-rated credit shall be made by Ameristar Fence Products. Reimbursement for the costs of removal and installation of materials are not included in the guarantee, nor will Ameristar Fence Products provide those services.

The above constitutes the complete warranty by the manufacturer. No other agreement, written or implied, is valid. Ameristar Fence Products does not authorize any other person or agent to make any other express warranties. Ameristar Fence Products neither assumes nor authorizes any other person or agent to assume any other liability in connection with WireWorks Plus Commercial Welded Wire Architectural Fence System. Some jurisdictions do not allow limitations on how long an implied warranty lasts, nor do they allow an exclusion or limitation of incidental or consequential damages; therefore, the limitations and exclusions noted herein may not apply.

Effective: 01/01/18

WIREWOKS PLUS® | SINGLE SWING GATE SPECIFICATIONS

2"sq x 12ga GATE ENDS | 2"sq x 12ga RAILS | 2" x 6" x 6ga WELDED WIRE | 3.5' - 16' NOMINAL OPENINGS

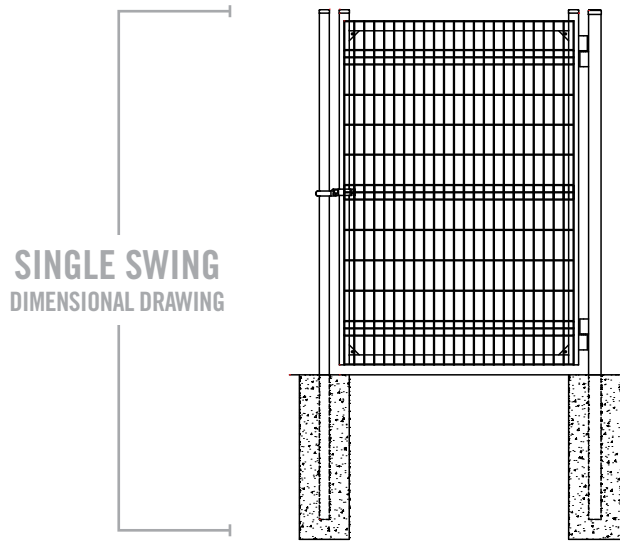

HGBS-25 / HGBS-3
180 HINGE & STRONG
ARM LATCH KITS

IGBSX25 / IGBSX3
BOX HINGE & FORK
LATCH KITS

SINGLE SWING
HARDWARE KITS & POST
INTERSPACES

OPENING	LEAF WIDTH*	HC	LC	P _s	HC	LC	P _s
3.5'	42"	1.25"	3"	46.25"	2"	2"	46"
4'	48"	1.25"	3"	52.25"	2"	2"	52"
5'	60"	1.25"	3"	64.25"	2"	2"	64"
6'	72"	1.25"	3"	76.25"	2"	2"	76"
7'	84"	1.25"	3"	88.25"	2"	2"	88"
8'	96"	1.25"	3"	100.25"	2"	2"	100"
9'	108"	1.25"	3"	112.25"	2"	2"	112"
10'	120"	1.25"	3"	124.25"	2"	2"	124"
11'	132"	1.25"	3"	136.25"	2"	2"	136"
12'	144"	1.25"	3"	148.25"	2"	2"	148"
13'	156"	1.25"	3"	160.25"	2"	2"	160"
14'	168"	1.25"	3"	172.25"	2"	2"	172"
15'	180"	1.25"	3"	184.25"	2"	2"	184"
16'	192"	1.25"	3"	196.25"	2"	2"	196"

W = width* | HC = hinge clearance | LC = latch clearance | P_s = gate post spacing**
* From outside to outside | ** From inside to inside

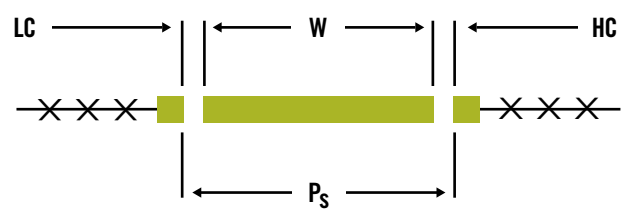

Effective: 01/01/18

WIREWORKS PLUS® | DOUBLE SWING GATE SPECIFICATIONS

2"sq x 12ga GATE ENDS | 2"sq x 12ga RAILS | 2"x 6"x 6ga WELDED WIRE | 7' - 32' NOMINAL OPENINGS

DOUBLE SWING
DIMENSIONAL DRAWING

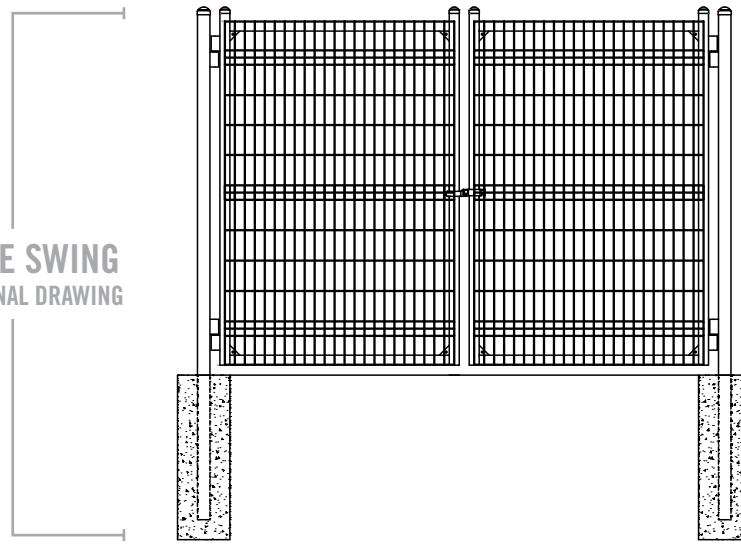

HGBD
180 HINGE & STRONG
ARM LATCH KIT

IGBDX
BOX HINGE & FORK
LATCH KIT

DOUBLE SWING
HARDWARE KITS & POST
INTERSPACES

OPENING	LEAF WIDTH*	HC	LC	P _d	HC	LC	P _d
7'	42"	1.25"	3"	89.5"	2"	2"	90"
8'	48"	1.25"	3"	101.5"	2"	2"	102"
10'	60"	1.25"	3"	125.5"	2"	2"	126"
12'	72"	1.25"	3"	149.5"	2"	2"	150"
14'	84"	1.25"	3"	173.5"	2"	2"	174"
16'	96"	1.25"	3"	197.5"	2"	2"	198"
18'	108"	1.25"	3"	221.5"	2"	2"	222"
20'	120"	1.25"	3"	245.5"	2"	2"	246"
22'	132"	1.25"	3"	269.5"	2"	2"	270"
24'	144"	1.25"	3"	293.5"	2"	2"	294"
26'	156"	1.25"	3"	317.5"	2"	2"	318"
28'	168"	1.25"	3"	341.5"	2"	2"	342"
30'	180"	1.25"	3"	365.5"	2"	2"	366"
32'	192"	1.25"	3"	389.5"	2"	2"	390"

W = width (x2)* | HC = hinge clearance (x2) | LC = latch clearance
 P_d = gate post spacing**

* From outside to outside | ** From inside to inside

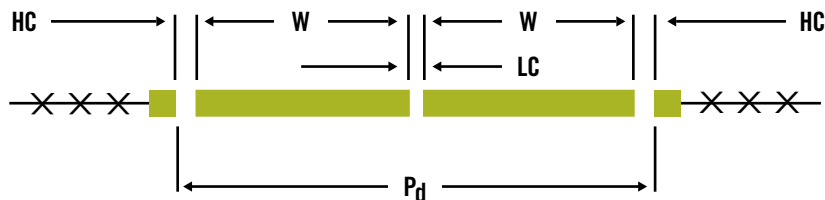

Effective: 01/01/18

WIREWOKS PLUS® | V-FOLD WELDED WIRE GATES

GATE HARDWARE SOLD SEPARATELY

	OPENING	ITEM NUMBER	WEIGHT	STOCKING
4' HEIGHT	3½'	5WP⊗04-42	55	⊗
	4'	5WP⊗04-48	60	⊗
	5'	5WP⊗04-60	70	⊗
	6'	5WP⊗04-72	79	⊗
	7'	5WP⊗04-84	100	⊗
	8'	5WP⊗04-96	109	⊗
	9'	5WP⊗04-108	118	⊗
	10'	5WP⊗04-120	128	⊗
	11'	5WP⊗04-132	137	⊗
	12'	5WP⊗04-144	147	⊗
5' HEIGHT	13'	5WP⊗04-156	156	⊗
	14'	5WP⊗04-168	165	⊗
	15'	5WP⊗04-180	175	⊗
	16'	5WP⊗04-192	184	⊗
	3½'	5WP⊗05-42	64	⊗
	4'	5WP⊗05-48	70	⊗
	5'	5WP⊗05-60	80	⊗
	6'	5WP⊗05-72	90	⊗
	7'	5WP⊗05-84	115	⊗
	8'	5WP⊗05-96	125	⊗
9'	5WP⊗05-108	135	⊗	
10'	5WP⊗05-120	146	⊗	
11'	5WP⊗05-132	156	⊗	
12'	5WP⊗05-144	166	⊗	
13'	5WP⊗05-156	177	⊗	
14'	5WP⊗05-168	187	⊗	
15'	5WP⊗05-180	197	⊗	
16'	5WP⊗05-192	208	⊗	

⊗ = COLOR OPTIONS AVAILABLE | **B** = Black **G** = Green **N** = Bronze
S = Sand **TB** = Tube Brown
W = White

⊙ = NON-STOCKED PRODUCT
 For details, see Ameristar's Sales Policy in the catalog guide.

Effective: 01/01/18

WIREWORKS PLUS® | V-FOLD WELDED WIRE GATES

GATE HARDWARE SOLD SEPARATELY

	OPENING	ITEM NUMBER	WEIGHT	STOCKING
6' HEIGHT	3½'	5WP⊗06-42	73	⊗
	4'	5WP⊗06-48	79	⊗
	5'	5WP⊗06-60	90	⊗
	6'	5WP⊗06-72	102	⊗
	7'	5WP⊗06-84	130	⊗
	8'	5WP⊗06-96	141	⊗
	9'	5WP⊗06-108	152	⊗
	10'	5WP⊗06-120	164	⊗
	11'	5WP⊗06-132	175	⊗
	12'	5WP⊗06-144	186	⊗
8' HEIGHT	13'	5WP⊗06-156	197	⊗
	14'	5WP⊗06-168	209	⊗
	15'	5WP⊗06-180	220	⊗
	16'	5WP⊗06-192	231	⊗
	3½'	5WP⊗08-42	88	⊗
	4'	5WP⊗08-48	94	⊗
	5'	5WP⊗08-60	106	⊗
	6'	5WP⊗08-72	118	⊗
	7'	5WP⊗08-84	153	⊗
	8'	5WP⊗08-96	165	⊗
9'	5WP⊗08-108	178	⊗	
10'	5WP⊗08-120	190	⊗	
11'	5WP⊗08-132	202	⊗	
12'	5WP⊗08-144	214	⊗	
13'	5WP⊗08-156	227	⊗	
14'	5WP⊗08-168	239	⊗	
15'	5WP⊗08-180	251	⊗	
16'	5WP⊗08-192	263	⊗	

⊗ = **COLOR OPTIONS AVAILABLE** | **B** = Black **G** = Green **N** = Bronze
S = Sand **TB** = Tube Brown
W = White

⊙ = **NON-STOCKED PRODUCT**
 For details, see Ameristar's Sales Policy in the catalog guide.

Effective: 01/01/18

WIREWOKS ANTI-CLIMB®

WIREWOKS PLUS®

WIREWOKS PLUS® | WELDED WIRE STEEL FENCE

Effective: 01/01/18

AMERISTAR

ASSA ABLOY

| TO PLACE YOUR ORDER CALL 888-333-3422 | VISIT AMERISTARFENCE.COM