

MONTAGE COMMERCIAL[®]



COMMERCIAL ORNAMENTAL STEEL FENCE

Montage Commercial steel fences have *redefined the commercial fence industry* with strength that matches the *level of security demanded*. In the past commercial fencing was defined as a chain link fence with three strands of barbwire, today Montage Commercial ornamental fences are the *standard for security fencing*.

PRIMARY APPLICATIONS

- **Commercial Developments**
- **Municipal Facilities**
- **Self Storage**
- **Parking Facilities**
- **Parks & Recreation**
- **Schools & Universities**



FENCE PRODUCTS

AMERISTARFENCE.COM | 888-333-3422

ASSA ABLOY, the global leader in door opening solutions

AMERISTAR[®]

ASSA ABLOY

MONTAGE COMMERCIAL[®]

COMMERCIAL ORNAMENTAL STEEL FENCE

.75"sq x 14ga PICKETS | 1.4375" x 1.5" x 14ga RAILS | 2.5"sq x 14ga POSTS

Each picket is precisely welded at each rail intersection providing all-terrain flexibility and aesthetics.

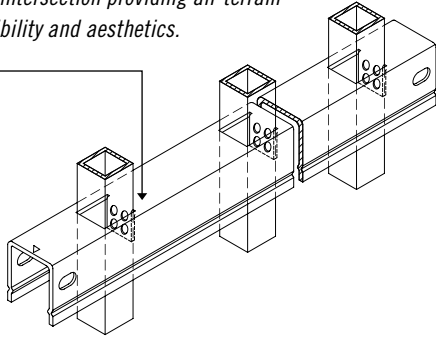

STYLE OPTIONS



Also available in Pool, Pet & Play (3" air spacing) – styles vary

PROFUSION WELDED STEEL



All Montage fence panels are fabricated using Ameristar's ProFusion welding process. This technique combines laser and fusion technology to create a virtually invisible structural connection at every picket to rail intersection. Unlike typical aluminum fence systems that are held together with unsightly screws, the ProFusion weld used with Montage promotes a "good neighbor" profile with sleek lines and no exposed picket to rail fasteners. When compared to aluminum fencing, Montage's welded steel construction is unmatched in strength and durability.



E-COAT[™] PROTECTIVE FINISH

Montage galvanized steel framework is subjected to a multi-stage pre-treatment/wash (with zinc phosphate), followed by a duplex cathodic electrocoat system consisting of an epoxy primer, which significantly increases corrosion protection, and an acrylic topcoat, which provides the protection necessary to withstand adverse weathering effects. This process results in years of maintenance-free ownership.



20 YEAR LIMITED WARRANTY

The Montage families of fencing products are manufactured from superior quality materials by skilled craftsmen with the highest standards of workmanship in the industry. Ameristar is confident in offering Montage with a 20 year limited warranty.



DOMESTIC MANUFACTURING

Ameristar is committed to providing products that are manufactured in the USA. We have made significant investments in technology, process improvement, and employee training in an effort to secure American jobs and combat inferior import products.



FENCE PRODUCTS

TO PLACE YOUR ORDER CALL 888-333-3422

VISIT AMERISTARFENCE.COM

MONTAGE COMMERCIAL® | 3 & 4-RAIL OPTIONS | 3" & 4"* AIR-SPACE OPTIONS

STANDARD BOTTOM AVAILABLE | *Available in Invincible only

PATENT NUMBERS: 7071439, 7621510, 7980534, 8523150, 9840854

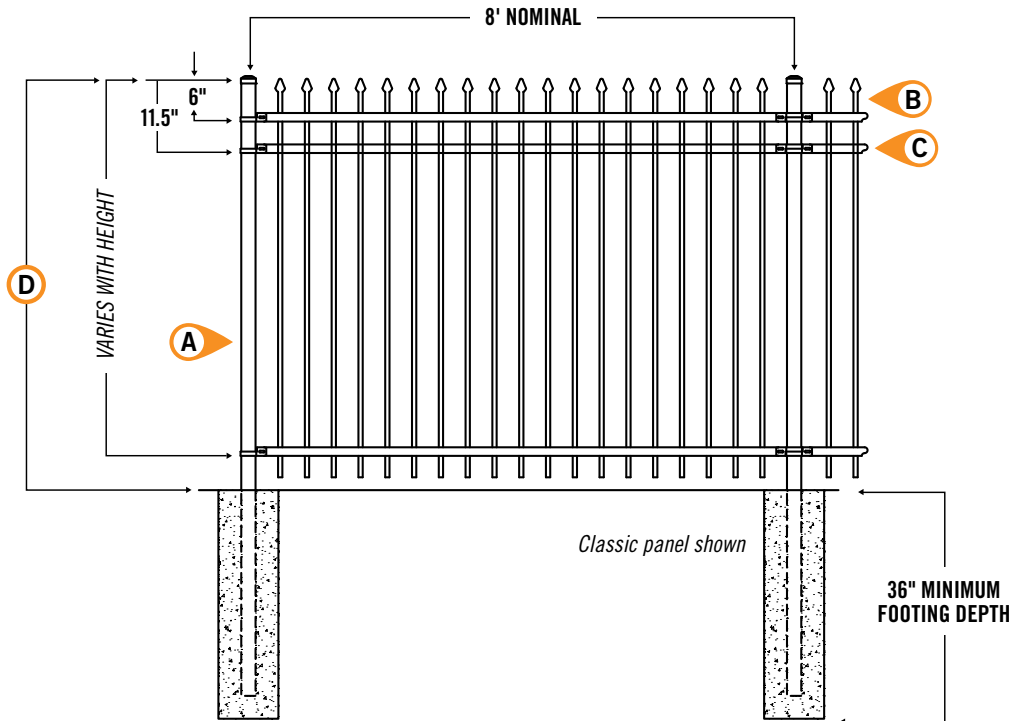

- Ⓐ 2.5"sq x 14ga POSTS
- Ⓑ 0.75"sq x 14ga PICKETS
- Ⓒ 1.4375"w x 1.5"h x 14ga RAILS
- Ⓓ 7' & 8' PANEL HEIGHTS

Refer to construction specification & tables within this section for recommended post space by bracket type

Effective: 01/01/18

MONTAGE COMMERCIAL® | 3-RAIL PANELS | 4" AIR GAP

STANDARD BOTTOM | 8' PANEL LENGTH (92" / 90.5"† actual width) | 19 / 20† PICKETS PER PANEL | 25 PANELS PER PALLET

PANEL	ITEM NUMBER	WEIGHT	STOCKING
7'	1R☒⊗3828	114 / 116†	CB MB IB
8'	1R☒⊗3948	124 / 129†	CB MB IB

☒ = FENCE STYLES AVAILABLE | **C** = Classic **M** = Majestic **G** = Genesis
I = Invincible†

⊗ = COLOR OPTIONS AVAILABLE | **B** = Black **N** = Bronze

⊙ = NON-STOCKED PRODUCT
 For details, see Ameristar's Sales Policy in the catalog guide.

Notes: Genesis panels are packaged with BLACK picket plugs for black & bronze.

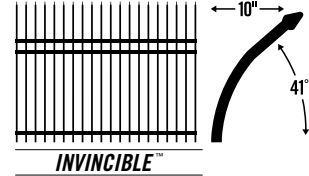
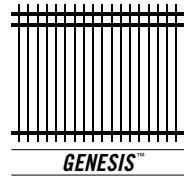
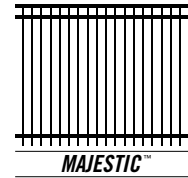
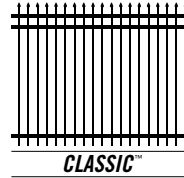

MONTAGE COMMERCIAL® | 3-RAIL PANELS | 3" AIR GAP

STANDARD BOTTOM | 8' PANEL LENGTH (92" actual width) | 24 PICKETS PER PANEL | 25 PANELS PER PALLET

PANEL	ITEM NUMBER	WEIGHT	STOCKING
7'	1R☒⊗3828-3	135 lbs	⊙
8'	1R☒⊗3948-3	148 lbs	⊙

☒ = FENCE STYLES AVAILABLE | **C** = Classic **M** = Majestic **G** = Genesis

⊗ = COLOR OPTIONS AVAILABLE | **B** = Black **N** = Bronze

⊙ = NON-STOCKED PRODUCT
 For details, see Ameristar's Sales Policy in the catalog guide.

Notes: Genesis panels are packaged with BLACK picket plugs for black & bronze.

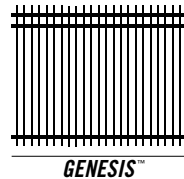
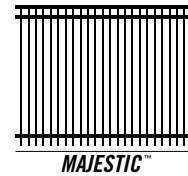
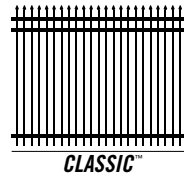

Effective: 01/01/18

MONTAGE COMMERCIAL® | 4-RAIL PANELS | 4" AIR GAP

STANDARD BOTTOM | 8' PANEL LENGTH (92" / 90.5"† actual width) | 19 / 20† PICKETS PER PANEL | 25 PANELS PER PALLET

PANEL	ITEM NUMBER	WEIGHT	STOCKING
7'	1R☒⊗4828	121 / 124†	☉
8'	1R☒⊗4948	132 / 137†	☉

☒ = FENCE STYLES AVAILABLE | **C** = Classic **M** = Majestic **G** = Genesis
I = Invincible†

⊗ = COLOR OPTIONS AVAILABLE | **B** = Black **N** = Bronze

☉ = NON-STOCKED PRODUCT
 For details, see Ameristar's Sales Policy in the catalog guide.

Notes: Genesis panels are packaged with BLACK picket plugs for black & bronze.

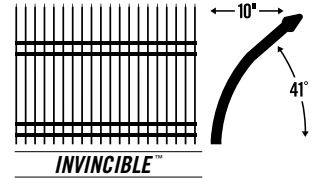
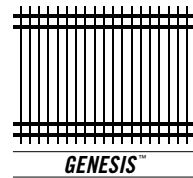
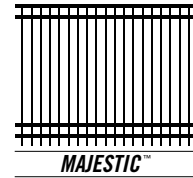
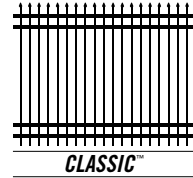

MONTAGE COMMERCIAL® | 4-RAIL PANELS | 3" AIR GAP

STANDARD BOTTOM | 8' PANEL LENGTH (92" actual width) | 24 PICKETS PER PANEL | 25 PANELS PER PALLET

PANEL	ITEM NUMBER	WEIGHT	STOCKING
7'	1R☒⊗4828-3	143 lbs	☉
8'	1R☒⊗4948-3	156 lbs	☉

☒ = FENCE STYLES AVAILABLE | **C** = Classic **M** = Majestic **G** = Genesis

⊗ = COLOR OPTIONS AVAILABLE | **B** = Black **N** = Bronze

☉ = NON-STOCKED PRODUCT
 For details, see Ameristar's Sales Policy in the catalog guide.

Notes: Genesis panels are packaged with BLACK picket plugs for black & bronze.

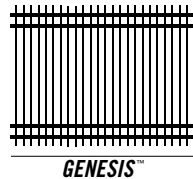
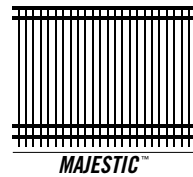
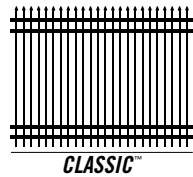

Effective: 01/01/18

MONTAGE COMMERCIAL® | BRACKETS

AVAILABLE IN BAG QUANTITIES ONLY

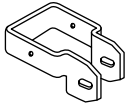

DESCRIPTION	SIZE	ITEM NUMBER	BAG QTY	BOX QTY	WEIGHT
Universal Boulevard Bracket	2.5"	B⊗112SR	2	40 bags	.15 lbs

Bags packaged with: #14 x .75" self-drilling screws | .25" x 2" carriage bolts | .25" tri groove security nuts

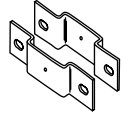

Universal Line Bracket	2.5"	B⊗114SR	2	40 bags	.84 lbs
-------------------------------	------	---------	---	---------	---------

Bags packaged with: #14 x .75" self-drilling screws | .25" x 2" carriage bolts | .25" tri groove security nuts

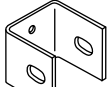

Flat Mount Bracket	n/a	B⊗111SR	2	80 bags	.27 lbs
---------------------------	-----	---------	---	---------	---------

Bags packaged with 4 of each:
 #14 x .75" self-drilling screws | .25" x 2" carriage bolts | .25" tri groove security nuts



Swivel Bracket	n/a	B⊗113	2	40 bags	.20 lbs
-----------------------	-----	-------	---	---------	---------

Bags packaged with: #10 x .75" self-drilling screws | #10 x .625" Phillips flat head screws

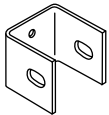

Invincible Flat Mount Bracket	B⊗118	B⊗118SR	2	50 bags	.30 lbs
--------------------------------------	-------	---------	---	---------	---------

Bags packaged with:
 #14 x .75" self-drilling screws | .25" x 2" carriage bolts | .25" tri groove security nuts

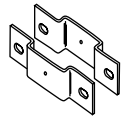

Invincible Line Bracket	2.5"	B⊗119SR	2	24 bags	.95 lbs
	3"	B⊗120SR	2	24 bags	1.05 lbs

Bags packaged with: #14 x .75" self-drilling screws | .25" x 2" carriage bolts | .25" tri groove security nuts

⊗ = COLOR OPTIONS AVAILABLE | B = Black | N = Bronze

MONTAGE COMMERCIAL® | CUSTOM FINISHES

WARRANTY ON CUT COMPONENTS VOID WITHOUT PROPER TOUCH-UP APPLICATION*

*For details & the guidelines for the proper 3-step process, see Ameristar's Sales Policy in the catalog guide

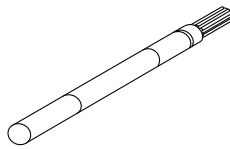

PAINT PEN

.5 lbs / P⊗100

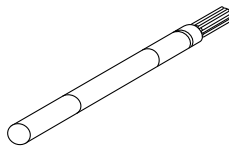

ZINC-RICH PAINT PEN

.5 lbs / PZ100

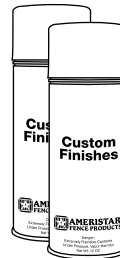

SPRAY PAINT

1.1 lbs / F⊗100

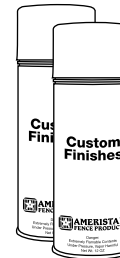

ZINC-RICH PRIMER





1.1 lbs / FZ100

⊗ = COLOR OPTIONS AVAILABLE | B = Black | N = Bronze

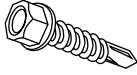
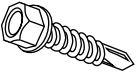
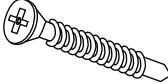
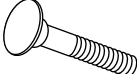

Effective: 01/01/18

MONTAGE COMMERCIAL® | FASTENERS & ADORNMENTS

AVAILABLE IN BOX QUANTITIES ONLY (Phillips head screws sold individually)

DESCRIPTION	ITEM NUMBER / BLACK	BAG QTY	WEIGHT EA
 #14 x .75" Tek Screw <i>Steel hex head self-drilling screws for attaching Montage Plus brackets & adornments</i>	H⊗524P-50	50	.6 lbs
 #10 x .75" Tek Screw <i>Steel hex head self-drilling screws for attaching Montage Plus brackets & adornments</i>	H⊗539P-50	50	.35 lbs
 #10 x .625" Phillips Head Tek Screw <i>Steel flat head screws for setting angle on Montage Plus swivel brackets</i>	H⊗519P	1	.005 lbs
 .25" x 2" Carriage Bolt <i>Steel carriage bolt for Montage Plus brackets</i>	H⊗516P	1	.027 lbs
 .25" Tri Groove Security Nut	3-0033-⊠P-20	20	.3 lbs
 Fastener Socket	6-0058PFG	1	.06 lbs
 One-Way Screw Remover	33246P	1	.10 lbs

⊗ = COLOR OPTIONS AVAILABLE | **B** = Black **N** = Bronze
 ⊠ = COLOR OPTIONS AVAILABLE | **1** = Black **2** = Bronze

 QUAD FLARE .75" / .15 lbs A⊗ 518	 TRIAD .75" / .15 lbs A⊗ 520R	 ROYALTY .75" / .21 lbs A⊗ 525
--	--	---

.75" PRESS FIT PICKET FINIALS

- » 19 finials required per panel with 4" air-space
- » 24 finials required per panel with a 3" air-space

⊗ = COLOR OPTIONS AVAILABLE | **B** = Black **N** = Bronze

NOTE: Picket plugs are available in bag quantities only / 19 plugs per bag. Item number = PB7519P

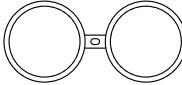
 BUTTERFLY SCROLL .75" / .7 lbs H⊗ 506	 DOUBLE RINGS .75" / .2 lbs A⊗ 112
---	---

MONTAGE COMMERCIAL PANEL ADORNMENTS

- » Fit in between / on the face of top rails on 3-rail panels
- » #10 x .75" self-drilling screws included
- » 9 adornments required per panel
- » Die cast aluminum
- » Double Rings not for use with 3" air-space

⊗ = COLOR OPTIONS AVAILABLE | **B** = Black **N** = Bronze

Effective: 01/01/18

MONTAGE COMMERCIAL® | STEEL SQUARE POSTS

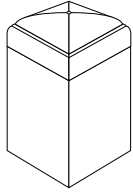

STEEL POSTS

	POST LENGTH	ITEM NUMBER	WEIGHT
2.5"sq. x 14ga.	8'	WP⊗ 25096-14	20 lbs
	9'	WP⊗ 25108-14	23 lbs
	10'	WP⊗ 25120-14	25 lbs
	11'	WP⊗ 25132-14	27 lbs
2.5"sq. x 12ga.	7'	P⊗ 25084	22 lbs
	8'	P⊗ 25096	26 lbs
	9'	P⊗ 25108	28 lbs
	10'	P⊗ 25120	31 lbs
	11'	P⊗ 25132	35 lbs
	12'	P⊗ 25144	36 lbs
3"sq. x 12ga.	7'	P⊗ 30084	30 lbs
	8'	P⊗ 30096	34 lbs
	9'	P⊗ 30108	39 lbs
	10'	P⊗ 30120	43 lbs
	11'	P⊗ 30132	47 lbs
	12'	P⊗ 30144	51 lbs
4"sq. x 11ga.	7'	P⊗ 40084	47 lbs
	8'	P⊗ 40096	54 lbs
	9'	P⊗ 40108	61 lbs
	10'	P⊗ 40120	67 lbs
	11'	P⊗ 40132	74 lbs
	12'	P⊗ 40144	81 lbs
6"sq. x .1875 wall	7'	P⊗ 60084	102 lbs
	8'	P⊗ 60096	116 lbs
	9'	P⊗ 60108	131 lbs
	10'	P⊗ 60120	145 lbs
	11'	P⊗ 60132	160 lbs
	12'	P⊗ 60144	174 lbs
8"sq. x .25 wall	9'	P⊗ 80108	233 lbs
	10'	P⊗ 80120	259 lbs
	11'	P⊗ 80132	285 lbs
	12'	P⊗ 80144	311 lbs

⊗ = COLOR OPTIONS AVAILABLE | **B** = Black **N** = Bronze

NOTE: In locations subject to freezing temperatures, where posts are grouted into core-drilled holes, a .25" diameter hole should be drilled into the post approximately .5" above the elevation to allow for drainage of ground water build-up. The drilled hole must be wiped clean and be dry prior to applying Ameristar zinc primer and color finish.

Effective: 01/01/18

MONTAGE COMMERCIAL® | STEEL PLATED SQUARE POSTS

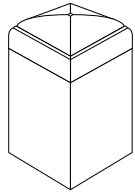

STEEL POSTS

	POST LENGTH	PLATE SIZE	ITEM NUMBER	WEIGHT
2.5"sq. x 12ga.	7'	5" sq. x .25" / .5625" holes (8833G)	P⊗ 25084P	26 lbs
	8'	5" sq. x .25" / .5625" holes (8833G)	P⊗ 25096P	28 lbs
	9'	5" sq. x .25" / .5625" holes (8833G)	P⊗ 25108P	31 lbs
3"sq. x 12ga.	7'	6" sq. x .25" / .5625" holes (5003G)	P⊗ 30084P	34 lbs
	8'	6" sq. x .25" / .5625" holes (5003G)	P⊗ 30096P	39 lbs
	9'	6" sq. x .25" / .5625" holes (5003G)	P⊗ 30108P	43 lbs
4"sq. x 11ga.	7'	8" sq. x .375" / .5625" holes (8876G)	P⊗ 40084P	54 lbs
	8'	8" sq. x .375" / .5625" holes (8876G)	P⊗ 40096P	61 lbs
	9'	8" sq. x .375" / .5625" holes (8876G)	P⊗ 40108P	67 lbs

⊗ = COLOR OPTIONS AVAILABLE | B = Black N = Bronze

NOTE: Posts used with Majestic may require an additional 1" longer than the panel or gate height, depending on the grade elevation.

MONTAGE COMMERCIAL® | POST CAPS

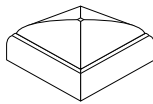

STANDARD FLAT CAP
Steel

CAP SIZE	ITEM NUMBER	WEIGHT
2.5"sq	A⊗ 507	.3 lbs
3"sq	A⊗ 508	.3 lbs
4"sq	A⊗ 509	.4 lbs
6"sq	A⊗ 515	.8 lbs
8"sq	A⊗ 801	2 lbs



BALL CAP
Aluminum

CAP SIZE	ITEM NUMBER	WEIGHT
2.5"sq	A⊗ 513	.7 lbs
3"sq	A⊗ 516	.8 lbs
4"sq	A⊗ 517	2 lbs
6"sq	A⊗ 521	8 lbs

INVINCIBLE POST CAP ASSEMBLY

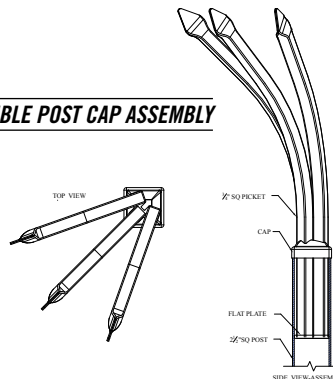

CAP SIZE	ITEM NUMBER	WEIGHT
2.5"sq	1RI⊗ 100	8.2 lbs
3"sq	2RI⊗ 100	9 lbs

⊗ = COLOR OPTIONS AVAILABLE | B = Black N = Bronze W = White
 S = Sand

Effective: 01/01/18

MONTAGE COMMERCIAL® | CONSTRUCTION SPECIFICATION 32 31 19

COMMERCIAL STEEL ORNAMENTAL FENCE SYSTEM – FUSION WELDED & RACKABLE

PART 1 - GENERAL

1.01 WORK INCLUDED

The contractor shall provide all labor, materials and appurtenances necessary for installation of the welded ornamental steel fence system defined herein at (*specify project site*).

1.02 RELATED WORK

Section _____ - Earthwork

Section _____ - Concrete

1.03 SYSTEM DESCRIPTION

The manufacturer shall supply a total fence system of (*specify Montage Commercial® standard picket space or Montage Commercial Pool, Pet & Play® 3" air space*) Welded and Rackable (ATF – All Terrain Flexibility) Ornamental Steel (*for standard picket space, specify Classic™, Majestic™, Genesis™, or Invincible™; for 3" air space, specify Classic, Majestic, or Genesis*) design. The ornamental fence system shall be (*specify 7' height or 8' height*) from grade. The system shall include all components (*i.e., panels, posts, gates and hardware*) required.

1.04 QUALITY ASSURANCE

The contractor shall provide laborers and supervisors who are thoroughly familiar with the type of construction involved and materials and techniques specified.

1.05 REFERENCES

- **ASTM A653/A653M** – Standard Specification for Steel Sheet, Zinc-Coated (Galvanized) or Zinc-Iron Alloy Coated (Galvannealed) by the Hot-Dip Process
- **ASTM B117** – Practice for Operating Salt-Spray (Fog) Apparatus
- **ASTM D523** – Test Method for Specular Gloss.
- **ASTM D714** – Test Method for Evaluating Degree of Blistering in Paint
- **ASTM D1654** – Test Method for Evaluation of Painted or Coated Specimens Subjected to Corrosive Environments
- **ASTM D2244** – Test Method for Calculation of Color Differences from Instrumentally Measured Color Coordinates.
- **ASTM D2794** – Test Method for Resistance of Organic Coatings to the Effects of Rapid Deformation (Impact)
- **ASTM D3359** – Test Method for Measuring Adhesion by Tape Test
- **ASTM D6695** - Standard Practice for Xenon-Arc Exposures of Paint and Related Coatings
- **ASTM F2408** – Ornamental Fences Employing Galvanized Steel Tubular Pickets

1.06 SUBMITTAL

The manufacturer's literature shall be submitted prior to installation.

1.07 PRODUCT HANDLING AND STORAGE

Upon receipt at the job site, all materials shall be checked to ensure that no damage occurred during shipping or handling. Materials shall be stored in such a manner to ensure proper ventilation and drainage, and to protect against damage, weather, vandalism and theft.

1.08 PRODUCT WARRANTY

- A. All structural fence components (*i.e. rails, pickets, and posts*) shall be warranted within specified limitations, by the manufacturer for a period of 20 years from date of original purchase. Warranty shall cover any defects in material finish, including cracking, peeling, chipping, blistering or corroding.
- B. Reimbursement for labor necessary to restore or replace components that have been found to be defective under the terms of manufacturer's warranty shall be guaranteed for five (5) years from date of original purchase.

PART 2 - MATERIALS

2.01 MANUFACTURER

The fence system shall conform to (*specify Montage Commercial standard picket space or Montage Commercial Pool, Pet & Play 3" air space*) Welded and Rackable (ATF – All Terrain Flexibility) Ornamental Steel, (*for standard picket space, specify Classic, Majestic, Genesis, or Invincible; for 3" air space, specify Classic, Majestic, or Genesis*) design, *extended picket* bottom rail treatment, (*specify 3-Rail, 4-Rail, or 3-Rail with Double Rings, 4-Rail with Double Rings*) style manufactured by Ameristar Fence Products, Inc., in Tulsa, Oklahoma.

2.02 MATERIAL

- A. Steel material for fence panels and posts shall conform to the requirements of **ASTM A653/A653M**, with a minimum yield strength of 45,000 psi (310 MPa) and a minimum zinc (hot-dip galvanized) coating weight of 0.60 oz/ft² (184 g/m²), Coating Designation G-60.
- B. Material for pickets shall be .75" square x 14 Ga. tubing. The rails shall be steel channel, 1.5" x 1.4375" x 14 Ga. Picket holes in the rail shall be spaced (*specify 4.675" o.c. for standard picket space or 3.500" o.c. for 3" air space*). Fence posts and gate posts shall meet the minimum size requirements of **Table 1**.

Effective: 01/01/18

MONTAGE COMMERCIAL® | CONSTRUCTION SPECIFICATION 32 31 19

COMMERCIAL STEEL ORNAMENTAL FENCE SYSTEM – FUSION WELDED & RACKABLE

2.03 FABRICATION

- A. Pickets, rails and posts shall be pre-cut to specified lengths. Rails shall be pre-punched to accept pickets.
- B. Pickets shall be inserted into the pre-punched holes in the rails and shall be aligned to standard spacing using a specially calibrated alignment fixture. The aligned pickets and rails shall be joined at each picket-to-rail intersection by Ameristar's proprietary fusion welding process, thus completing the rigid panel assembly (*Note: The process produces a virtually seamless, spatter-free good-neighbor appearance, equally attractive from either side of the panel.*)
- C. The manufactured panels and posts shall be subjected to an inline electrode position coating (E-Coat) process consisting of a multi-stage pretreatment/wash, followed by a duplex application of an epoxy primer and an acrylic topcoat. The minimum cumulative coating thickness of epoxy and acrylic shall be 2 mils (0.058 mm). The color shall be (*specify Black or Bronze*). The coated panels and posts shall be capable of meeting the performance requirements for each quality characteristic shown in **Table 2** (*Note: The requirements in Table 2 meet or exceed the coating performance criteria of ASTM F2408*).
- D. The manufactured fence system shall be capable of meeting the vertical load, horizontal load, and infill performance requirements for Industrial weight fences under **ASTM F2408**.
- E. Gates with an out to out leaf dimension less than and including 72" shall be fabricated using Montage Commercial ornamental panel material and 1.75" sq. x 14ga. gate ends. Gate leafs greater than 72" shall be fabricated using ForeRunner rails, 17 gauge pickets, intermediate uprights, gussets and 1.75" sq. x 14ga. gate ends. All rail and upright intersections shall be joined by welding. All picket and rail intersections shall also be joined by welding.

PART 3 - EXECUTION

3.01 PREPARATION

All new installation shall be laid out by the contractor in accordance with the construction plans.

3.02 INSTALLATION

Fence post shall be spaced according to **Table 3**, plus or minus .25". For installations that must be raked to follow sloping grades, the post spacing dimension must be measured along the grade. Fence panels shall be attached to posts with brackets supplied by the manufacturer. Posts shall be set in concrete footers having a minimum depth of 36" (*Note: In some cases, local restrictions of freezing weather conditions may require a greater depth*). The "Earthwork" and "Concrete" sections of this specification shall govern material requirements for the concrete footer. Posts setting by other methods such as plated posts or grouted core-drilled footers are permissible only if shown by engineering analysis to be sufficient in strength for the intended application.

3.03 FENCE INSTALLATION MAINTENANCE

When cutting/drilling rails or posts adhere to the following steps to seal the exposed steel surfaces; 1) Remove all metal shavings from cut area. 2) Apply zinc-rich primer to thoroughly cover cut edge and/or drilled hole; let dry. 3) Apply 2 coats of custom finish paint matching fence color. Failure to seal exposed surfaces per steps 1-3 above will negate warranty. Ameristar spray cans or paint pens shall be used to prime and finish exposed surfaces; it is recommended that paint pens be used to prevent overspray. Use of non-Ameristar parts or components will negate the manufactures' warranty.

3.04 GATE INSTALLATION

Gate posts shall be spaced according to the manufacturers' gate drawings, dependent on standard out-to-out gate leaf dimensions and gate hardware selected. Type and quantity of gate hinges shall be based on the application; weight, height, and number of gate cycles. The manufacturers' gate drawings shall identify the necessary gate hardware required for the application. Gate hardware shall be provided by the manufacture of the gate and shall be installed per manufacturer's recommendations.

3.05 CLEANING

The contractor shall clean the jobsite of excess materials; post-hole excavations shall be scattered uniformly away from posts.

SEE REFERENCED TABLES ON THE FOLLOWING PAGE

Effective: 01/01/18

MONTAGE COMMERCIAL® | CONSTRUCTION SPECIFICATION 32 31 19

COMMERCIAL STEEL ORNAMENTAL FENCE SYSTEM – FUSION WELDED & RACKABLE

TABLE 1

MINIMUM SIZES FOR MONTAGE PLUS POSTS	
FENCE POSTS	PANEL HEIGHTS
2½" x 14 ga.	7' & 8' heights
GATE LEAF	GATE HEIGHT
	7' & 8' heights
up to 4'	2.5" x 12 gauge
4'1" to 6'	3" x 12 gauge
6'1" to 10'	4" x 11 gauge
10'1" to 16'	6" x 3/16" wall

TABLE 2

COATING PERFORMANCE REQUIREMENTS		
QUALITY CHARACTERISTICS	ASTM TEST METHOD	PERFORMANCE REQUIREMENTS
ADHESION	D3359 – METHOD B	Adhesion (retention of coating) over 90% of test area (tape and knife kit test).
CORROSION RESISTANCE	B117, D714, D1654	Corrosion resistance over 1,500 hours (scribed per D1654; failure mode is accumulation of 1/8" coating loss from scribe or medium #8 blisters)
IMPACT RESISTANCE	D2794	Impact resistance over 60" lb. (forward impact using 0.625" ball).
WEATHERING RESISTANCE	D822 D2244, D523 (60° method)	Weathering resistance over 1,000 hours (failure mode is 60% loss of gloss or color variance of more than 3 delta-E color units).

TABLE 3

MONTAGE COMMERCIAL POST SPACING BY BRACKET TYPE										
SPAN	Invincible / 8' nominal (91.445" rail)				Classic, Genesis & Majestic / 8' nominal (91.95" rail)					
	2½"	3"	2½"	3"	2½"	3"	2½"	3"	2½"	3"
BRACKET TYPE	Montage Commercial Invincible Flat Mount (BB118SR)		Montage Commercial Invincible Line 2½" (BB119SR) / 3" (BB120SR)		Montage Commercial Universal (BB112SR)		Montage Commercial Line Blvd. (BB114SR)		Montage Commercial Swivel (BB113)*	
POST SETTINGS ± ¼" O.C.	94"	94½"	94"	94½"	95"	95½"	95"	95½"	*95"	*95½"

*When using BB113 swivel brackets on either or both ends of a panel installation, care must be taken to ensure the spacing between post and adjoining pickets meets applicable codes. This will require trimming one or both ends of the panel.

Effective: 01/01/18

MONTAGE COMMERCIAL® | LIMITED WARRANTY

WELDED ORNAMENTAL FENCE

Ameristar's Montage Commercial® welded ornamental fences are manufactured from the highest quality materials by skilled craftsmen to meet the highest standards of workmanship in the industry. Galvanized steel framework is subjected to a multi-stage pretreatment/wash, followed by a duplex cathodic electro-coat system consisting of an epoxy primer, which significantly increases corrosion protection, and an acrylic liquid topcoat, which provides the protection necessary to withstand adverse weathering effects.

The electro-coated surface on all Montage Commercial welded ornamental panels and posts are guaranteed under normal and intended usage, against cracking, peeling, chipping, blistering or corroding commencing with the original purchase date and extending according to the applications defined in the table below. Normal and intended usage does not include physical damage, abrasion, or heavy salt spray exposure to the protective coating.

THE FOLLOWING ACTS AND/OR OMISSIONS WILL VOID THE SUBJECT WARRANTY:

- Damage to the product caused by the property owner by use of landscape, gardening equipment, chemicals that may cause damage, and/or water sprinklers with high mineral content;
- Damage caused by adhesion of chicken wire, chain link mesh, welded wire, or other similar substance to the product;
- Damage caused by allowing plant life of any sort to grow directly upon or in contact with any portion of the product or sap from trees;
- Any alteration to the product itself by the property owner including any on-site cutting or welding; and/or, failure to follow any and all maintenance instructions provided by Ameristar® at the time of sale to the original purchaser even if these instructions are not forwarded to the ultimate claimant under this warranty.
- When cutting Montage Commercial immediately seal the exposed surfaces by 1) Removing all metal shavings from the cut area 2) Applying zinc-rich primer to thoroughly cover cut edge and drilled hole and, after letting dry, 3) Applying two (2) coats of custom finish spray paint matching fence color. Failure to seal exposed surfaces per steps 1-3 above will negate warranty.
- If contractor uses non-Ameristar parts/components, this will negate the warranty.

Ameristar Montage Commercial welded ornamental fences are also guaranteed for the same period of time against defects in workmanship or materials. Should any Montage Commercial welded ornamental panel or post manufactured by Ameristar fail in accordance with any of the above conditions, Ameristar warrants to the original purchaser their redemption through replacement, renewal or issuance of a pro-rated credit.

APPLICATION	LENGTH OF WARRANTY
Fence Installations 0 to 1 Mile from Salt Water Coast Line	5 YEARS
Fence Installations 1 Mile to 10 Miles from Salt Water Coast Line	10 YEARS
Fence Installations Over 10 Miles from Salt Water Coast Line	20 YEARS

Regardless of location and years in service, evidence of historical salt spray exposure shall be considered as grounds to void any warranty obligations.

The choice of redemption method is solely at the discretion of Ameristar. If the pro-rated alternative is chosen, the amount will be based on the original cost of materials at the date of purchase multiplied by the appropriate time and exposure factor from the table below:

Notice of failure under the conditions of this warranty shall be sent to Ameristar or its authorized representative, in writing, together with proof of purchase and shall specify the nature of the defect and when it was first observed as well as photographs of current site conditions. Should the fence be improperly installed, Ameristar shall not be responsible for guaranteed performance or appearance of the material. Neither does this guarantee apply when failure or damage is due to improper use or application, abuse or misuse, salt spray exposure (see Table and Note above), vandalism, or acts of God. Ameristar reserves the right to inspect the material to determine validity of the claim.

Upon acceptance of the claim by Ameristar or its authorized representative, redemption by replacement, renewal or issuance of a pro-rated credit shall be made by Ameristar. Reimbursement for labor necessary to restore and/or replace components that have been found defective under the terms of this warranty is guaranteed to the original purchaser for a period of five (5) years from the original purchase date. Ameristar reserves the right to select the qualified company or individual to perform the labor to repair or replace the components that are deemed to be defective under the terms of this warranty.

The above constitutes the complete warranty by the manufacturer. No other agreement, written or implied, is valid. Ameristar Fence Products does not authorize any other person or agent to make any other express warranties. Ameristar neither assumes nor authorizes any other person or agent to assume any other liability in connection with the Montage Commercial welded ornamental fence system.

Effective: 01/01/18

MONTAGE COMMERCIAL® | SINGLE SWING GATE SPECIFICATIONS

1.75"sq x 14ga GATE ENDS | 1.4375"w x 1.5"h x 14ga RAILS | .75"sq x 14ga PICKETS | 3.5' - 16' NOMINAL OPENINGS

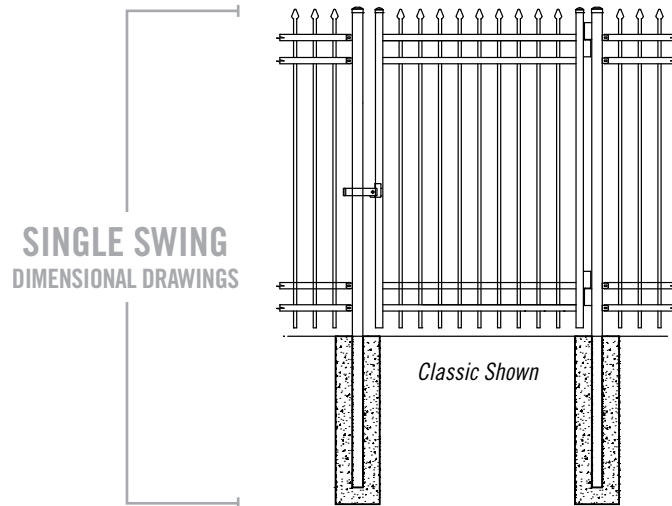

SGBSX25 / SGB3 FORK LATCH / BOX HINGE KITS | CGBS-25 CGBS-3 / CGBS-4 COMMERCIAL HINGE WITH STRONG ARM | HGBS-25 HGBS-3 / HGBS-4 HEAVY COMMERCIAL HINGE KITS

SINGLE SWING
 HARDWARE KITS &
 POST INTERSPACES

OPENING	LEAF WIDTH*	HC	LC	P _S	HC	LC	P _S	HC	LC	P _S
3.5'	40"	2"	2"	44"	1"	3"	44"	1.25"	3"	44.25"
4'	49.5"	2"	2"	53.5"	1"	3"	53.5"	1.25"	3"	53.75"
5'	58.75"	2"	2"	62.75"	1"	3"	62.75"	1.25"	3"	63"
6'	68"	2"	2"	72"	1"	3"	72"	1.25"	3"	72.25"
7'	86.75"	2"	2"	90.75"	1"	3"	90.75"	1.25"	3"	91"
8'	95.5"	2"	2"	99.5"	1"	3"	99.5"	1.25"	3"	99.75"
9'	105.5"	2"	2"	109.5"	1"	3"	109.5"	1.25"	3"	109.75"
10'	114.75"	2"	2"	118.75"	1"	3"	118.75"	1.25"	3"	119"
11'	133.5"	2"	2"	137.5"	1"	3"	137.5"	1.25"	3"	137.75"
12'	143"	2"	2"	147"	1"	3"	147"	1.25"	3"	147.25"
13'	152.25"	2"	2"	156.25"	1"	3"	156.25"	1.25"	3"	156.5"
14'	171"	2"	2"	175"	1"	3"	175"	1.25"	3"	175.25"
15'	180.25"	2"	2"	184.25"	1"	3"	184.25"	1.25"	3"	184.5"
16'	189.75"	2"	2"	193.75"	1"	3"	193.75"	1.25"	3"	194"

W = width* | HC = hinge clearance | LC = latch clearance | P_S = gate post spacing**
 * From outside to outside | ** From inside to inside

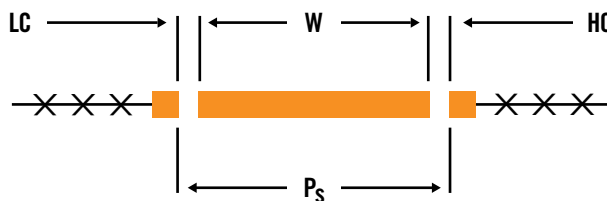

Effective: 01/01/18

MONTAGE COMMERCIAL® | DOUBLE SWING GATE SPECIFICATIONS

1.75"sq x 14ga GATE ENDS | 1.4375"w x 1.5"h x 14ga RAILS | .75"sq x 14ga PICKETS | 7' - 16' NOMINAL OPENINGS

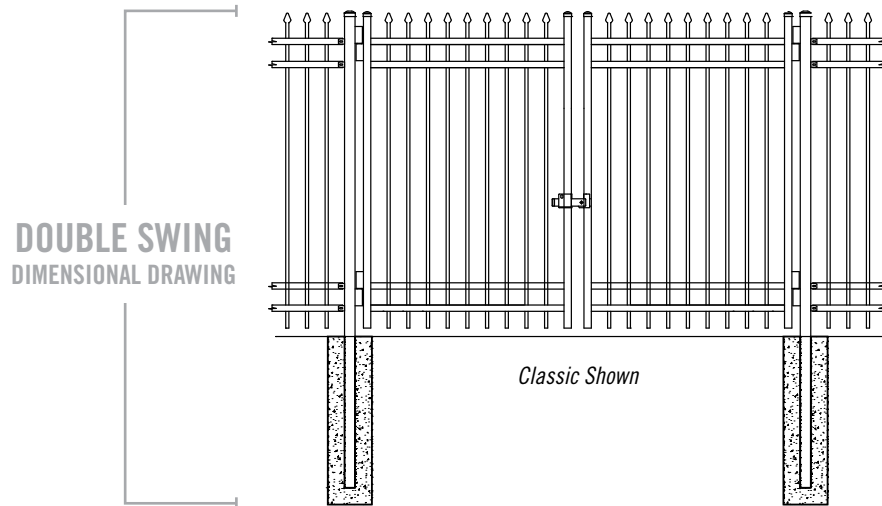

SGBDX FORK LATCH / BOX HINGE KITS | CGBD COMMERCIAL HINGE WITH STRONG ARM | HGBD HEAVY COMMERCIAL HINGE KITS

DOUBLE SWING
 HARDWARE KITS &
 POST INTERSPACES

OPENING	LEAF WIDTH*	HC	LC	P _d	HC	LC	P _d	HC	LC	P _d
7'	40"	2"	2"	86"	1"	2"	84"	1.25"	2"	84.5"
8'	49.5"	2"	2"	105"	1"	2"	103"	1.25"	2"	103.5"
10'	58.75"	2"	2"	123.5"	1"	2"	121.5"	1.25"	2"	122"
12'	68"	2"	2"	142"	1"	2"	140"	1.25"	2"	140.5"
14'	86.75"	2"	2"	179.5"	1"	2"	177.5"	1.25"	2"	178"
16'	95.5"	2"	2"	197"	1"	2"	195"	1.25"	2"	195.5"
18'	105.5"	2"	2"	217"	1"	2"	215"	1.25"	2"	215.5"
20'	114.75"	2"	2"	235.5"	1"	2"	233.5"	1.25"	2"	234"
22'	133.5"	2"	2"	273"	1"	2"	271"	1.25"	2"	271.5"
24'	143"	2"	2"	292"	1"	2"	290"	1.25"	2"	290.5"
26'	152.25"	2"	2"	310.5"	1"	2"	308.5"	1.25"	2"	309"
28'	171"	2"	2"	348"	1"	2"	346"	1.25"	2"	346.5"
30'	180.25"	2"	2"	366.5"	1"	2"	364.5"	1.25"	2"	365"
32'	189.75"	2"	2"	385.5"	1"	2"	383.5"	1.25"	2"	384"

W = width (x2)* | HC = hinge clearance (x2) | LC = latch clearance | P_d = gate post spacing**
 * From outside to outside | ** From inside to inside

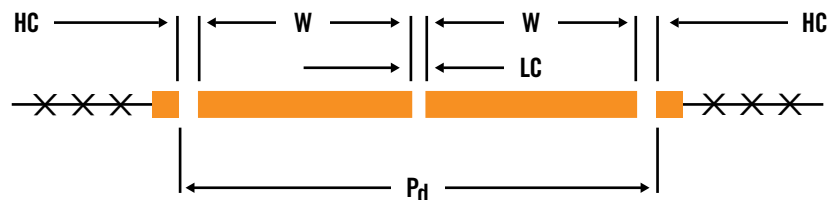

Effective: 01/01/18

MONTAGE COMMERCIAL® | 3-RAIL SINGLE SWING GATES

4" AIR GAP | STANDARD BOTTOM | GATE HARDWARE SOLD SEPARATELY

	OPENING	LEAF WIDTH	ITEM NUMBER	PICKET QTY	WEIGHT	STOCKING
7' HEIGHT	3½'	40"	1W☒⊗382-42	7 / 8†	65 / 68†	⊙
	4'	49½"	1W☒⊗382-48	9 / 10†	77 / 80†	⊙
	5'	58¾"	1W☒⊗382-60	11 / 12†	88 / 92†	⊙
	6'	68"	1W☒⊗382-72	13 / 14†	100 / 108†	⊙
	7'	86¾"	1W☒⊗382-84	17 / 18†	118 / 123†	⊙
	8'	95½"	1W☒⊗382-96	19 / 20†	130 / 139†	⊙
	9'	105½"	1W☒⊗382-108	21 / 22†	177 / 181†	⊙
	10'	114¾"	1W☒⊗382-120	23 / 24†	200 / 203†	⊙
	11'	133½"	1W☒⊗382-132	27 / 28†	236 / 240†	⊙
	12'	143"	1W☒⊗382-144	29 / 30†	272 / 276†	⊙
8' HEIGHT	13'	152¼"	1W☒⊗382-156	31 / 32†	282 / 286†	⊙
	14'	171"	1W☒⊗382-168	35 / 36†	292 / 295†	⊙
	15'	180¼"	1W☒⊗382-180	37 / 38†	309 / 314†	⊙
	16'	189¾"	1W☒⊗382-192	39 / 40†	325 / 330†	⊙
	3½'	40"	1W☒⊗394-42	7 / 8†	73 / 76†	⊙
	4'	49½"	1W☒⊗394-48	9 / 10†	86 / 90†	⊙
	5'	58¾"	1W☒⊗394-60	11 / 12†	99 / 103†	⊙
	6'	68"	1W☒⊗394-72	13 / 14†	112 / 121†	⊙
	7'	86¾"	1W☒⊗394-84	17 / 18†	132 / 137†	⊙
	8'	95½"	1W☒⊗394-96	19 / 20†	145 / 155†	⊙
8' HEIGHT	9'	105½"	1W☒⊗394-108	21 / 22†	193 / 197†	⊙
	10'	114¾"	1W☒⊗394-120	23 / 24†	220 / 224†	⊙
	11'	133½"	1W☒⊗394-132	27 / 28†	266 / 271†	⊙
	12'	143"	1W☒⊗394-144	29 / 30†	288 / 292†	⊙
	13'	152¼"	1W☒⊗394-156	31 / 32†	302 / 307†	⊙
	14'	171"	1W☒⊗394-168	35 / 36†	320 / 326†	⊙
	15'	180¼"	1W☒⊗394-180	37 / 38†	338 / 345†	⊙
	16'	189¾"	1W☒⊗394-192	39 / 40†	356 / 362†	⊙

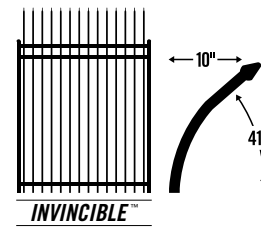
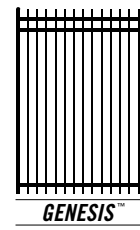
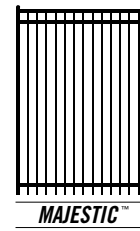
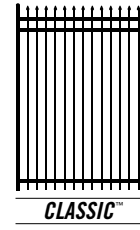

☒ = FENCE STYLES AVAILABLE | C = Classic M = Majestic G = Genesis I = Invincible†

⊗ = COLOR OPTIONS AVAILABLE | B = Black N = Bronze

⊙ = NON-STOCKED PRODUCT

For details, see Ameristar's Sales Policy in the catalog guide.

Effective: 01/01/18

AMERISTAR
 ASSA ABLOY

TO PLACE YOUR ORDER CALL 888-333-3422 | VISIT AMERISTARFENCE.COM

MONTAGE COMMERCIAL® | 3-RAIL SINGLE SWING GATES

3" AIR GAP | STANDARD BOTTOM | GATE HARDWARE SOLD SEPARATELY

	OPENING	LEAF WIDTH	ITEM NUMBER	PICKET QTY	WEIGHT	STOCKING
7' HEIGHT	3½'	40"	1R☒⊗382-42	9	74 lbs	☉
	4'	49½"	1R☒⊗382-48	12	86 lbs	☉
	5'	58¾"	1R☒⊗382-60	14	100 lbs	☉
	6'	68"	1R☒⊗382-72	17	117 lbs	☉
	7'	86¾"	1R☒⊗382-84	22	136 lbs	☉
	8'	95½"	1R☒⊗382-96	24	152 lbs	☉
8' HEIGHT	3½'	40"	1R☒⊗394-42	9	83 lbs	☉
	4'	49½"	1R☒⊗394-48	12	96 lbs	☉
	5'	58¾"	1R☒⊗394-60	14	112 lbs	☉
	6'	68"	1R☒⊗394-72	17	132 lbs	☉
	7'	86¾"	1R☒⊗394-84	22	152 lbs	☉
	8'	95½"	1R☒⊗394-96	24	170 lbs	☉

☒ = FENCE STYLES AVAILABLE | C = Classic | M = Majestic | G = Genesis | I = Invincible

⊗ = COLOR OPTIONS AVAILABLE | B = Black | N = Bronze

☉ = NON-STOCKED PRODUCT

For details, see Ameristar's Sales Policy in the catalog guide.

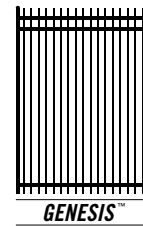
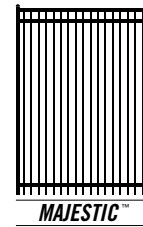
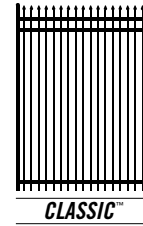

Effective: 01/01/18

MONTAGE COMMERCIAL® | 4-RAIL SINGLE SWING GATES

4" AIR GAP | STANDARD BOTTOM | GATE HARDWARE SOLD SEPARATELY

	OPENING	LEAF WIDTH	ITEM NUMBER	PICKET QTY	WEIGHT	STOCKING
7' HEIGHT	3½'	40"	1W☒☒482-42	7 / 8†	69 / 71†	☉
	4'	49½"	1W☒☒482-48	9 / 10†	81 / 84†	☉
	5'	58¾"	1W☒☒482-60	11 / 12†	93 / 97†	☉
	6'	68"	1W☒☒482-72	13 / 14†	106 / 114†	☉
	7'	86¾"	1W☒☒482-84	17 / 18†	126 / 131†	☉
	8'	95½"	1W☒☒482-96	19 / 20†	138 / 148†	☉
	9'	105½"	1W☒☒482-108	21 / 22†	194 / 200†	☉
	10'	114¾"	1W☒☒482-120	23 / 24†	222 / 227†	☉
	11'	133½"	1W☒☒482-132	27 / 28†	260 / 265†	☉
	12'	143"	1W☒☒482-144	29 / 30†	299 / 306†	☉
8' HEIGHT	13'	152¼"	1W☒☒482-156	31 / 32†	310 / 316†	☉
	14'	171"	1W☒☒482-168	35 / 36†	322 / 328†	☉
	15'	180¼"	1W☒☒482-180	37 / 38†	342 / 348†	☉
	16'	189¾"	1W☒☒482-192	39 / 40†	361 / 367†	☉
	3½'	40"	1W☒☒494-42	7 / 8†	77 / 80†	☉
	4'	49½"	1W☒☒494-48	9 / 10†	90 / 94†	☉
	5'	58¾"	1W☒☒494-60	11 / 12†	104 / 108†	☉
	6'	68"	1W☒☒494-72	13 / 14†	118 / 127†	☉
	7'	86¾"	1W☒☒494-84	17 / 18†	140 / 145†	☉
	8'	95½"	1W☒☒494-96	19 / 20†	153 / 164†	☉
8' HEIGHT	9'	105½"	1W☒☒494-108	21 / 22†	210 / 214†	☉
	10'	114¾"	1W☒☒494-120	23 / 24†	242 / 248†	☉
	11'	133½"	1W☒☒494-132	27 / 28†	290 / 296†	☉
	12'	143"	1W☒☒494-144	29 / 30†	315 / 322†	☉
	13'	152¼"	1W☒☒494-156	31 / 32†	330 / 337†	☉
	14'	171"	1W☒☒494-168	35 / 36†	350 / 357†	☉
	15'	180¼"	1W☒☒494-180	37 / 38†	371 / 377†	☉
	16'	189¾"	1W☒☒494-192	39 / 40†	392 / 398†	☉

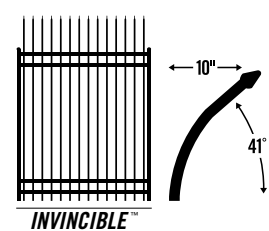
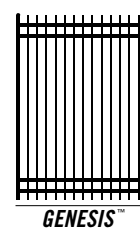
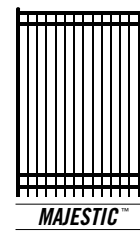
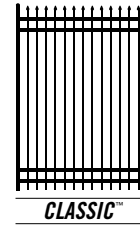

☒ = FENCE STYLES AVAILABLE | C = Classic M = Majestic G = Genesis I = Invincible†
 ☒ = COLOR OPTIONS AVAILABLE | B = Black N = Bronze
 ☉ = NON-STOCKED PRODUCT
 For details, see Ameristar's Sales Policy in the catalog guide.

Effective: 01/01/18

MONTAGE COMMERCIAL® | 4-RAIL SINGLE SWING GATES

3" AIR GAP | STANDARD BOTTOM | GATE HARDWARE SOLD SEPARATELY

	OPENING	LEAF WIDTH	ITEM NUMBER	PICKET QTY	WEIGHT	STOCKING
7' HEIGHT	3½'	40"	1R☒⊗482-42	9	78 lbs	⊙
	4'	49½"	1R☒⊗482-48	12	90 lbs	⊙
	5'	58¾"	1R☒⊗482-60	14	107 lbs	⊙
	6'	68"	1R☒⊗482-72	17	123 lbs	⊙
	7'	86¾"	1R☒⊗482-84	22	144 lbs	⊙
	8'	95½"	1R☒⊗482-96	24	160 lbs	⊙
8' HEIGHT	3½'	40"	1R☒⊗494-42	9	87 lbs	⊙
	4'	49½"	1R☒⊗494-48	12	101 lbs	⊙
	5'	58¾"	1R☒⊗494-60	14	119 lbs	⊙
	6'	68"	1R☒⊗494-72	17	138 lbs	⊙
	7'	86¾"	1R☒⊗494-84	22	160 lbs	⊙
	8'	95½"	1R☒⊗494-96	24	179 lbs	⊙

☒ = FENCE STYLES AVAILABLE | C = Classic | M = Majestic | G = Genesis

⊗ = COLOR OPTIONS AVAILABLE | B = Black | N = Bronze

⊙ = NON-STOCKED PRODUCT

For details, see Ameristar's Sales Policy in the catalog guide.

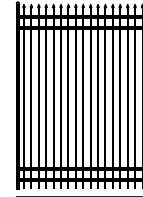

CLASSIC™

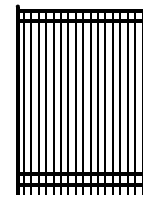

MAJESTIC™

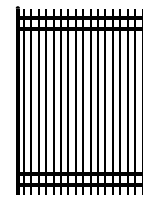

GENESIS™

Effective: 01/01/18

MONTAGE COMMERCIAL® | SINGLE SWING ARCHED GATE SPECIFICATIONS

1.75"sq x 14ga GATE ENDS | 1.4375"w x 1.5"h x 14ga RAILS | .75"sq x 14ga PICKETS | 3.5' - 6' NOMINAL OPENINGS

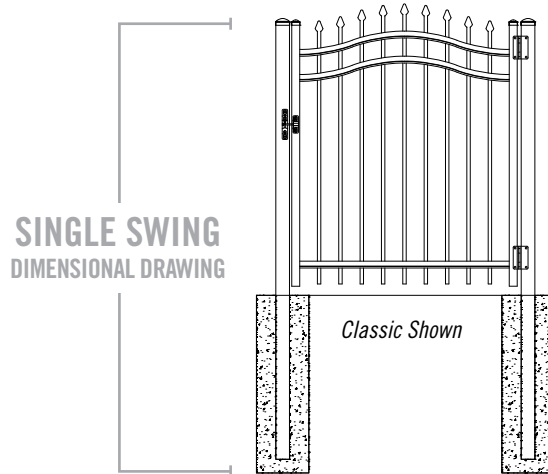

SINGLE SWING
 ARCHED
 HARDWARE KITS &
 POST INTERSPACES

SGBSX25 / SGBSX3
 FORK LATCH / BOX
 HINGE KITS

CGBS-25
 CGBS-3 / CGBS-4
 COMMERCIAL HINGE
 WITH STRONG ARM

HGBS-25
 HGBS-3 / HGBS-4
 HEAVY COMMERCIAL
 HINGE KITS

OPENING	LEAF WIDTH*	HC	LC	P _S	HC	LC	P _S	HC	LC	P _S
3½'	40"	2"	2"	44"	1"	3"	44"	1.25"	3"	44.25"
4'	49.5"	2"	2"	53.5"	1"	3"	53.5"	1.25"	3"	53.75"
5'	58.75"	2"	2"	62.75"	1"	3"	62.75"	1.25"	3"	63"
6'	68"	2"	2"	72"	1"	3"	72"	1.25"	3"	72.25"

W = width* | HC = hinge clearance | LC = latch clearance | P_S = gate post spacing**
 * From outside to outside | ** From inside to inside

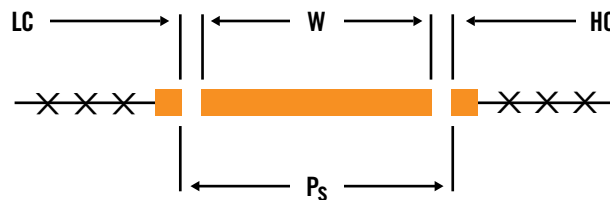

Effective: 01/01/18

MONTAGE COMMERCIAL® | DOUBLE SWING ARCHED GATE SPECIFICATIONS

1.75"sq x 14ga GATE ENDS | 1.4375"w x 1.5"h x 14ga RAILS | .75"sq x 14ga PICKETS | 7' - 14' NOMINAL OPENINGS

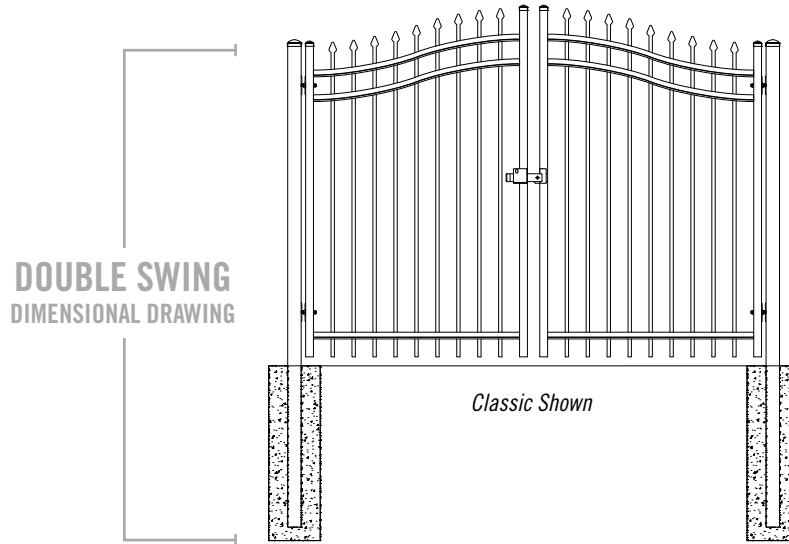

DOUBLE SWING
 HARDWARE KITS &
 POST INTERSPACES

OPENING	LEAF WIDTH*	SGBDX FORK LATCH / BOX HINGE KITS			CGBD COMMERCIAL HINGE WITH STRONG ARM			HGBD HEAVY COMMERCIAL HINGE KITS		
		HC	LC	P _d	HC	LC	P _d	HC	LC	P _d
7'	40"	2"	2"	86"	1"	2"	84"	1.25"	2"	84.5"
8'	49.5"	2"	2"	105"	1"	2"	103"	1.25"	2"	103.5"
10'	58.75"	2"	2"	123.5"	1"	2"	121.5"	1.25"	2"	122"
12'	68"	2"	2"	142"	1"	2"	140"	1.25"	2"	140.5"
14'	86.75"	2"	2"	179.5"	1"	2"	177.5"	1.25"	2"	178"

W = width (x2)* | HC = hinge clearance (x2) | LC = latch clearance | P_d = gate post spacing**
 * From outside to outside | ** From inside to inside

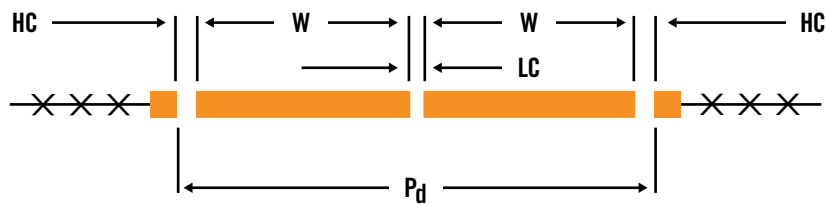

Effective: 01/01/18

MONTAGE COMMERCIAL® | 3-RAIL SINGLE SWING ARCHED GATES

4" AIR GAP | STANDARD BOTTOM | GATE HARDWARE SOLD SEPARATELY

	OPENING	LEAF WIDTH	ITEM NUMBER	PICKET QTY	WEIGHT	STOCKING
7' HEIGHT	3½'	40"	1W☒☉382-42A	7	70 lbs	☉
	4'	49½"	1W☒☉382-48A	9	83 lbs	☉
	5'	58¾"	1W☒☉382-60A	11	95 lbs	☉
	6'	68"	1W☒☉382-72A	13	108 lbs	☉

☒ = FENCE STYLES AVAILABLE | C = Classic M = Majestic G = Genesis

☉ = COLOR OPTIONS AVAILABLE | B = Black N = Bronze

☉ = NON-STOCKED PRODUCT

For details, see Ameristar's Sales Policy in the catalog guide.

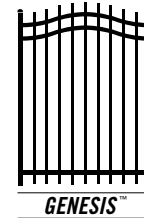
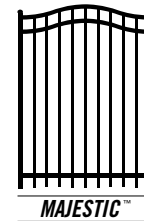
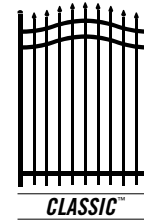

MONTAGE COMMERCIAL® | 3-RAIL DOUBLE SWING ARCHED GATES

4" AIR GAP | STANDARD BOTTOM | GATE HARDWARE SOLD SEPARATELY

	OPENING	LEAF WIDTH	ITEM NUMBER	PICKET QTY	WEIGHT	STOCKING
7' HEIGHT	7'	40"	1W☒☉382-84HD	14	134 lbs	☉
	8'	49½"	1W☒☉382-96HD	18	160 lbs	☉
	10'	58¾"	1W☒☉382-120HD	22	182 lbs	☉
	12'	68"	1W☒☉382-144HD	26	210 lbs	☉
	14'	86¾"	1W☒☉382-168HD	34	246 lbs	☉

☒ = FENCE STYLES AVAILABLE | C = Classic M = Majestic G = Genesis

☉ = COLOR OPTIONS AVAILABLE | B = Black N = Bronze

☉ = NON-STOCKED PRODUCT

For details, see Ameristar's Sales Policy in the catalog guide.

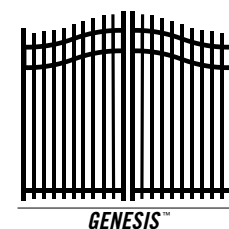
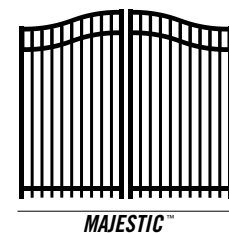
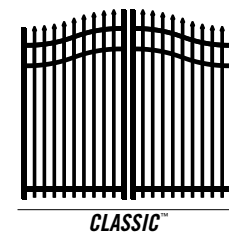

Notes Two gate leaves included for all double gates. Gate heights are nominal & gate widths are actual.

WARNING: Steel arched gates with EXTENDED PICKET BOTTOM exposure are NOT TO BE AUTOMATED!
 Extended picket bottom treatment does not meet ASTM standard F2200 for automated gates.

Notes: Genesis panels are packaged with BLACK picket plugs for black & bronze.

Effective: 01/01/18

MONTAGE COMMERCIAL® | 4-RAIL SINGLE SWING ARCHED GATES

4" AIR GAP | STANDARD BOTTOM | GATE HARDWARE SOLD SEPARATELY

OPENING	LEAF WIDTH	ITEM NUMBER	PICKET QTY	WEIGHT	STOCKING	
7' HEIGHT	3½'	40"	1W☒⊗482-42A	7	75 lbs	☉
	4'	49½"	1W☒⊗482-48A	9	87 lbs	☉
	5'	58¾"	1W☒⊗482-60A	11	100 lbs	☉
	6'	68"	1W☒⊗482-72A	13	114 lbs	☉

☒ = FENCE STYLES AVAILABLE | C = Classic M = Majestic G = Genesis

⊗ = COLOR OPTIONS AVAILABLE | B = Black N = Bronze

☉ = NON-STOCKED PRODUCT

For details, see Ameristar's Sales Policy in the catalog guide.

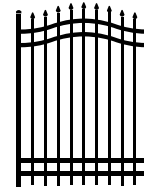

CLASSIC™

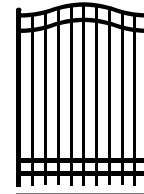

MAJESTIC™

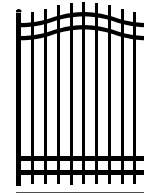

GENESIS™

MONTAGE COMMERCIAL® | 4-RAIL DOUBLE SWING ARCHED GATES

4" AIR GAP | STANDARD BOTTOM | GATE HARDWARE SOLD SEPARATELY

OPENING	LEAF WIDTH	ITEM NUMBER	PICKET QTY	WEIGHT	STOCKING	
7' HEIGHT	7'	40"	1W☒⊗482-84HD	14	142 lbs	☉
	8'	49½"	1W☒⊗482-96HD	18	168 lbs	☉
	10'	58¾"	1W☒⊗482-120HD	22	192 lbs	☉
	12'	68"	1W☒⊗482-144HD	26	222 lbs	☉
	14'	86¾"	1W☒⊗482-168HD	34	262 lbs	☉

☒ = FENCE STYLES AVAILABLE | C = Classic M = Majestic G = Genesis

⊗ = COLOR OPTIONS AVAILABLE | B = Black N = Bronze

☉ = NON-STOCKED PRODUCT

For details, see Ameristar's Sales Policy in the catalog guide.

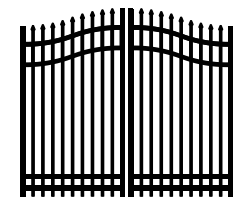

CLASSIC™

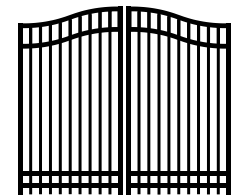

MAJESTIC™

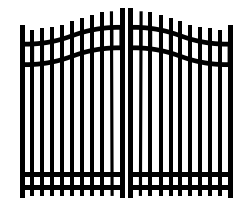

GENESIS™

Notes Two gate leaves included for all double gates. Gate heights are nominal & gate widths are actual.

WARNING: Steel arched gates with EXTENDED PICKET BOTTOM exposure are NOT TO BE AUTOMATED!

Extended picket bottom treatment does not meet ASTM standard F2200 for automated gates.

Genesis panels are packaged with BLACK picket plugs for black & bronze.

Effective: 01/01/18

MONTAGE COMMERCIAL® | SINGLE SWING ARCHED ESTATE GATE SPECIFICATIONS

2"sq x 14ga GATE ENDS | 1.4375"w x 1.5"h x 14ga RAILS | .75"sq x 14ga PICKETS | 3.5' - 6' NOMINAL OPENINGS

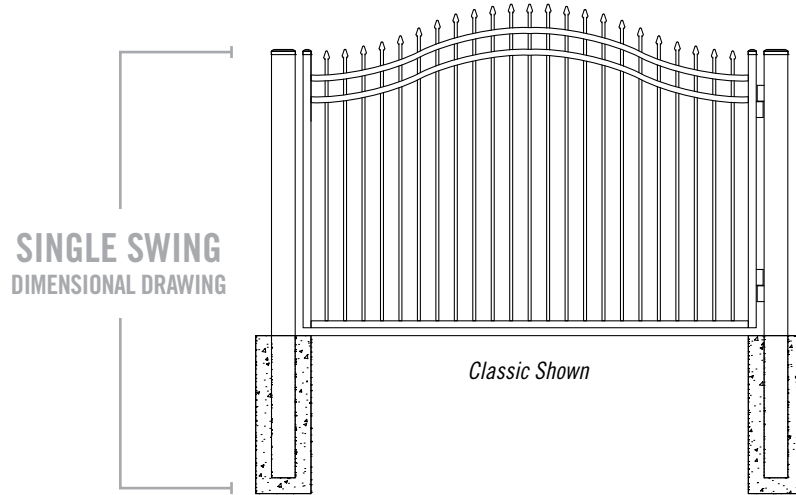

SINGLE SWING
 ARCHED
 HARDWARE KITS &
 POST INTERSPACES

SGBSX25 / SGBSX3
 FORK LATCH / BOX
 HINGE KITS

CGBS-25
 CGBS-3 / CBGS-4
 COMMERCIAL HINGE
 WITH STRONG ARM

HGBS-25
 HGBS-3 / HGBS-4
 HEAVY COMMERCIAL
 HINGE KITS

OPENING	LEAF WIDTH*	HC	LC	P _S	HC	LC	P _S	HC	LC	P _S
3½'	40"	2"	2"	44"	1"	3"	44"	1.25"	3"	44.5"
4'	49.5"	2"	2"	53.5"	1"	3"	53.5"	1.25"	3"	53.75"
5'	58.75"	2"	2"	62.75"	1"	3"	62.75"	1.25"	3"	63"
6'	68"	2"	2"	72"	1"	3"	72"	1.25"	3"	72.25"

W = width* | HC = hinge clearance | LC = latch clearance | P_S = gate post spacing**
 * From outside to outside | ** From inside to inside

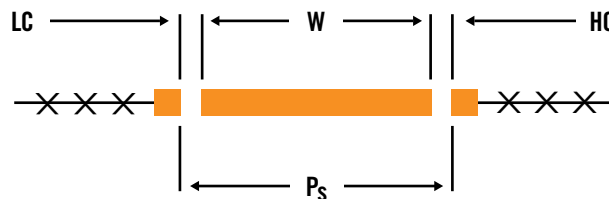

Effective: 01/01/18

AMERISTAR
 ASSA ABLOY

TO PLACE YOUR ORDER CALL 888-333-3422 | VISIT AMERISTARFENCE.COM

MONTAGE COMMERCIAL® | SINGLE SWING ARCHED ESTATE GATE SPECIFICATIONS

2"sq x 14ga GATE ENDS | 1.4375"w x 1.5"h x 14ga RAILS | .75"sq x 14ga PICKETS | 7' - 14' NOMINAL OPENINGS

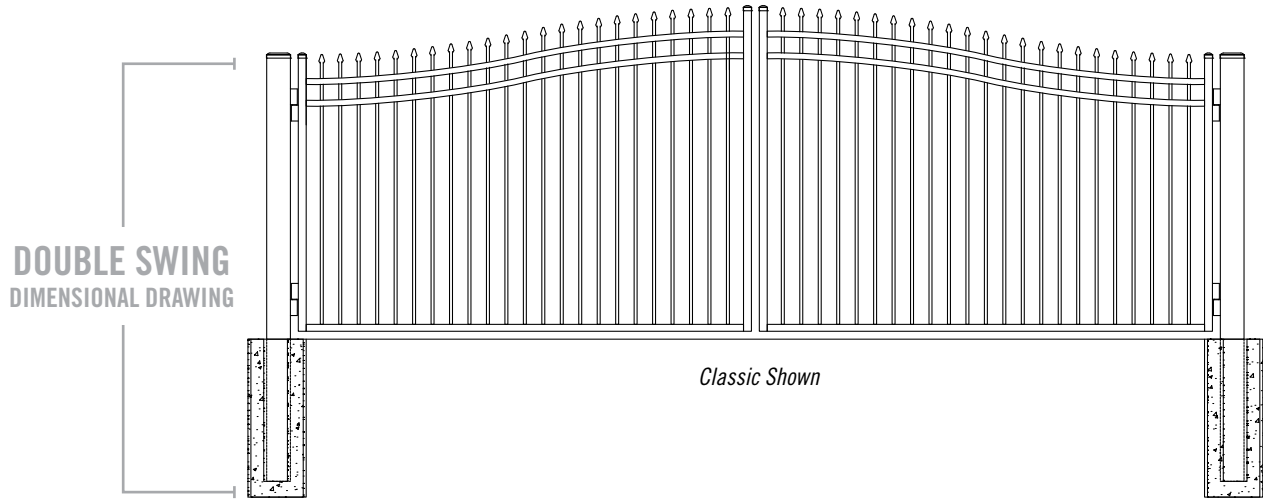

DOUBLE SWING
 HARDWARE KITS &
 POST INTERSPACES

OPENING	LEAF WIDTH*	SGBDX FORK LATCH / BOX HINGE KITS			CGBD COMMERCIAL HINGE WITH STRONG ARM			HGBD HEAVY COMMERCIAL HINGE KITS		
		HC	LC	P _d	HC	LC	P _d	HC	LC	P _d
7'	40"	2"	2"	86"	1"	2"	84"	1.25"	2"	84.5"
8'	49.5"	2"	2"	105"	1"	2"	103"	1.25"	2"	103.5"
10'	58.75"	2"	2"	123.5"	1"	2"	121.5"	1.25"	2"	122"
12'	68"	2"	2"	142"	1"	2"	140"	1.25"	2"	140.5"
14'	86.75"	2"	2"	179.5"	1"	2"	177.5"	1.25"	2"	178"

W = width (x2)* | HC = hinge clearance (x2) | LC = latch clearance | P_d = gate post spacing**
 * From outside to outside | ** From inside to inside

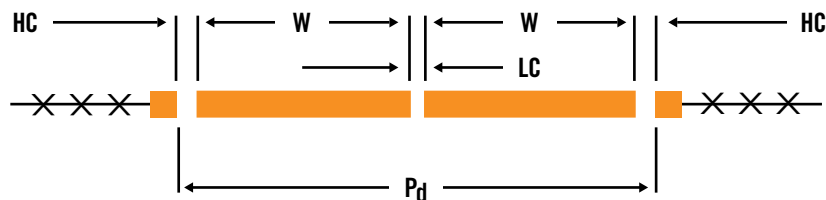

Effective: 01/01/18

MONTAGE COMMERCIAL® | 3-RAIL SINGLE SWING ESTATE GATES

4" AIR GAP | FLUSH BOTTOM | GATE HARDWARE SOLD SEPARATELY

7'
HEIGHT

OPENING	LEAF WIDTH	ITEM NUMBER	PICKET QTY	WEIGHT	STOCKING
8'	95½"	1W☒☒382F-96A	19	---	☉
10'	114¾"	1W☒☒382F-120A	23	---	☉
12'	143"	1W☒☒382F-144A	29	---	☉

☒ = FENCE STYLES AVAILABLE | **C** = Classic **M** = Majestic **G** = Genesis

☒ = COLOR OPTIONS AVAILABLE | **B** = Black **N** = Bronze

☉ = NON-STOCKED PRODUCT

For details, see Ameristar's Sales Policy in the catalog guide.

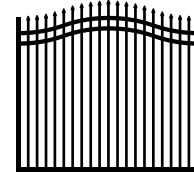

CLASSIC™

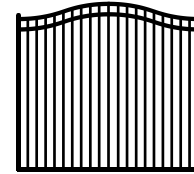

MAJESTIC™

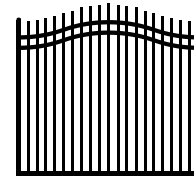

GENESIS™

MONTAGE COMMERCIAL® | 3-RAIL DOUBLE SWING ESTATE GATES

4" AIR GAP | FLUSH BOTTOM | GATE HARDWARE SOLD SEPARATELY

7'
HEIGHT

OPENING	LEAF WIDTH	ITEM NUMBER	PICKET QTY	WEIGHT	STOCKING
16'	95½"	1W☒☒382F-192HD	38	---	☉
18'	105½"	1W☒☒382F-216HD	42	---	☉
20'	114¾"	1W☒☒382F-240HD	46	---	☉
22'	133½"	1W☒☒382F-264HD	54	---	☉
24'	143"	1W☒☒382F-288HD	58	---	☉

☒ = FENCE STYLES AVAILABLE | **C** = Classic **M** = Majestic **G** = Genesis

☒ = COLOR OPTIONS AVAILABLE | **B** = Black **N** = Bronze

☉ = NON-STOCKED PRODUCT

For details, see Ameristar's Sales Policy in the catalog guide.

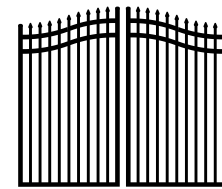

CLASSIC™

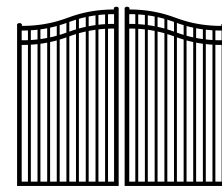

MAJESTIC™

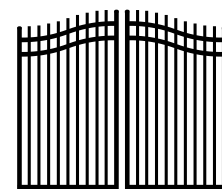

GENESIS™

Notes Two gate leaves included for all double gates. Gate heights are nominal & gate widths are actual.
 Genesis panels are packaged with BLACK picket plugs for black & bronze.

Effective: 01/01/18

MONTAGE COMMERCIAL® | 4-RAIL SINGLE SWING ESTATE GATES

4" AIR GAP | FLUSH BOTTOM | GATE HARDWARE SOLD SEPARATELY

7'
HEIGHT

OPENING	LEAF WIDTH	ITEM NUMBER	PICKET QTY	WEIGHT	STOCKING
8'	95½"	1W☒☉482F-96A	19	---	☉
10'	114¾"	1W☒☉482F-120A	23	---	☉
12'	143"	1W☒☉482F-144A	29	---	☉

☒ = FENCE STYLES AVAILABLE | C = Classic M = Majestic G = Genesis

☉ = COLOR OPTIONS AVAILABLE | B = Black N = Bronze

☉ = NON-STOCKED PRODUCT

For details, see Ameristar's Sales Policy in the catalog guide.

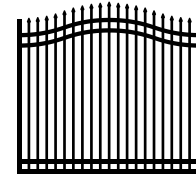

CLASSIC™

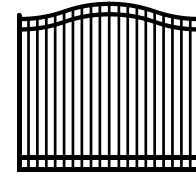

MAJESTIC™

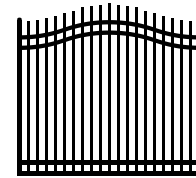

GENESIS™

MONTAGE COMMERCIAL® | 4-RAIL DOUBLE SWING ESTATE GATES

4" AIR GAP | FLUSH BOTTOM | GATE HARDWARE SOLD SEPARATELY

7'
HEIGHT

OPENING	LEAF WIDTH	ITEM NUMBER	PICKET QTY	WEIGHT	STOCKING
16'	95½"	1W☒☉482F-192HD	38	---	☉
18'	105½"	1W☒☉482F-216HD	42	---	☉
20'	114¾"	1W☒☉482F-240HD	46	---	☉
22'	133½"	1W☒☉482F-264HD	54	---	☉
24'	143"	1W☒☉482F-288HD	58	---	☉

☒ = FENCE STYLES AVAILABLE | C = Classic M = Majestic G = Genesis

☉ = COLOR OPTIONS AVAILABLE | B = Black N = Bronze

☉ = NON-STOCKED PRODUCT

For details, see Ameristar's Sales Policy in the catalog guide.

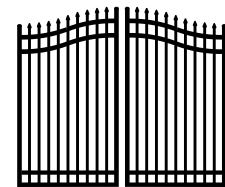

CLASSIC™

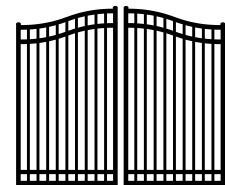

MAJESTIC™

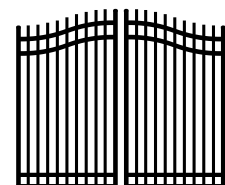

GENESIS™

Notes Two gate leaves included for all double gates. Gate heights are nominal & gate widths are actual.
 Genesis panels are packaged with BLACK picket plugs for black & bronze.

Effective: 01/01/18

MONTAGE COMMERCIAL® | GATE ENDS

1.75" x 14ga | GATES FABRICATED BY WELDING GATE ENDS TO PANEL REMNANTS ARE EXCLUDED FROM THE WARRANTY

SIZE	ITEM NUMBER	BOX QTY	WEIGHT
1.75" x 82"	1H⊗282	8	12.25 lbs
1.75" x 94"	1H⊗294	8	14.00 lbs

⊗ = COLOR OPTIONS AVAILABLE | **B** = Black | **N** = Bronze

Notes: 1.75" sq. pressed steel post caps are included in box for each gate end

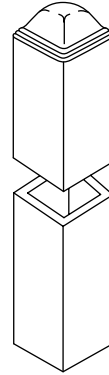

Effective: 01/01/18

Effective: 01/01/18

TO PLACE YOUR ORDER CALL 888-333-3422 | VISIT AMERISTARFENCE.COM |

AMERISTAR®
ASSA ABLOY

Effective: 01/01/18